

**Seating Arrangements Workbook**

**Reasoning**

25/7/2016

Ramandeep Singh

# SEATING ARRANGEMENT

## SET - 1

**Directions (Q1–Q6):** Study the following information carefully and answer the questions given below:

A group of seven members are sitting in a row facing south. There are three females in the group. Only males sit at the extreme ends of the row. Females sit adjacent to each other. They (persons) live in three different cities of the country at least two in each city. There are three persons between P and S. K is the immediate left of U and is on the immediate right of S. P is the immediate neighbour of R and N. There is only one person between P and U. S lives in Kanpur with only one person who is not a female. There are two persons between N and S. R lives in Delhi only with the person who is at extreme end. W is at the right end of the row. No female is neighbour of R and W. The one who is in the middle of the row has neighbours who live in Mumbai.

**Q1. Which of the following sit at the extreme ends of the row?**

- 1) R, S 2) W, P 3) R, W 4) S, R 5) P, R

**Q2. How many persons are there between R and N?**

- 1) One 2) Two 3) None 4) Four 5) Three

**Q3. Which of the following is the group of females?**

- 1) K, N, P 2) K, N, U 3) U, K, W 4) K, W, N 5) R, U, N

**Q4. Four of the following five are alike in a same way, find out the odd one?**

- 1) R, P 2) N, U 3) K, N 4) S, R 5) W, U

**Q5. Who among the following sits third to the right of one who lives in Kanpur?**

- 1) P 2) R 3) N 4) K 5) W

**Q6. Which of the following does match correctly?**

- 1) P–Male–Mumbai 2) U–Female–Mumbai 3) K–Male–Delhi  
4) W–Female–Mumbai 5) Both 3 and 2

## **ANSWER -**

1. 3
2. 1
3. 2
4. 5
5. 3
6. 2

## **SOLUTION -**

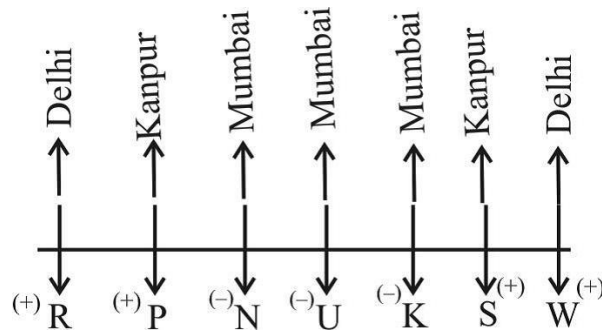

## SET – 2

**Directions (Q1–Q5):** Study the following information carefully and answer the questions given below:

Seven family members, viz – A, B, C, D, E, F and G are sitting around a circular table facing the centre, but not necessarily in the same order. Among them four are males and three are females. Grandfather is the immediate neighbor of his son and his grandson E, who is sitting on the immediate left of his wife. The wife of A is third to the left of her father-in-law. C is the father-in-law of F. D is brother of A. B is the daughter of A is sitting fourth to the right of A. A is son of C. B is not a neighbor of any male.

Q1. Which of the following group represent females according to the given arrangement ?

- 1) A, D, F 2) G, B, F 3) G, B, E 4) C, E, F 5) Can't be determined

Q2. Who is the grand father of E ?

- 1) A 2) B 3) C 4) Can't be determined 5) None of these

Q3. Which of the following sits second to the right of D ?

- 1) C 2) B 3) F 4) E 5) A

Q4. Which of the following statements (s) is/are true with respect to 'G' ?

- 1) G sits to the left of E and is a male. 2) G is wife of E. 3) G is daughter of A. 4) G is brother of A and B. 5) G is sister of D.

Q5. Which of the following pairs sit between D and G ?

- 1) A, B 2) B, E 3) C, A 4) F, E 5) B, F

**ANSWER –**

1. 2  
2. 3  
3. 1  
4. 2  
5. 5

**SOLUTION –**

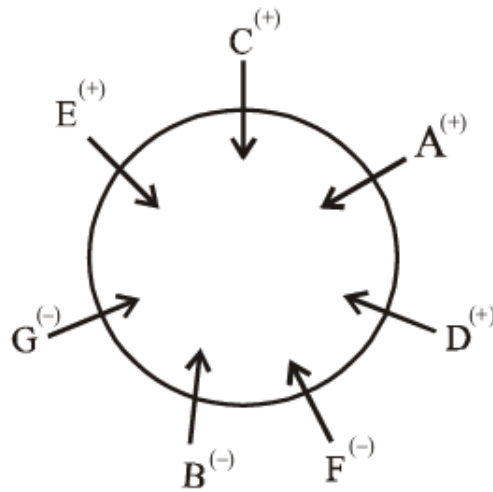

### SET – 3

**Directions (Q1- Q5) :** Study the following information carefully and answer the question given below:

Eight people P, Q, R, S, T, U, V and W are sitting around a circular table, facing the centre. Each of them is drinking a different beverages - Tea, Coffee, Juice, Mineral Water, Lemonade, Cola, Coconut Water and Milk, but not necessarily in the same order. Q is sitting second to the left of U. The person drinking Milk is an immediate neighbour of U. Only one person sits between the person drinking Mineral water and P. The person drinking coffee is on the immediate right of the person drinking Mineral water. W is second to the right of U. S is drinking milk. R and T are immediate neighbours. Neither R nor T is drinking mineral water. The person drinking lemonade is on the immediate left of Q. The person drinking Cola is second to the right of person drinking Coffee. The person drinking coconut water is an immediate neighbour of the person drinking Mineral water. R is second to the right of the person drinking Tea.

Q1. Who is second to the right of P ?

- 1) Q 2) R 3) S 4) T 5) U

Q2. Who among the following is drinking Coconut water ?

- 1) Q 2) V 3) W 4) U 5) T

Q3. What is the position of V with respect to the person drinking Milk ?

- 1) Third to the left 2) Second to the right 3) Second to the left 4) Third to the right 5) Immediate right

Q4. Four of the following five are alike in a certain way based on the given arrangement and hence form a group. Which of the following does not belong to the group ?

- 1) Tea - S 2) Juice - W 3) Mineral water - T 4) Lemonade - V 5) Cola - U

Q5. Which of the following person is drinking Tea ?

- 1) P 2) R 3) T 4) V 5) W

**ANSWER –**

1. 2

## Reasoning Seating Arrangements Workbook

- 2. 4
- 3. 2
- 4. 3
- 5. 1

**SOLUTION –**

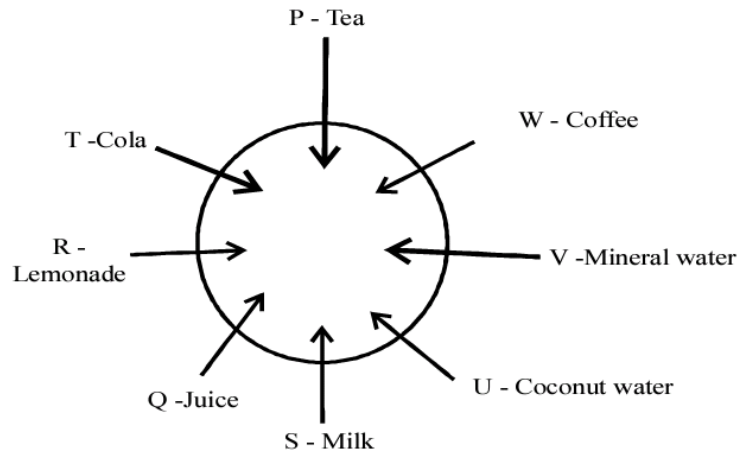

### **SET – 4**

**Directions (Q1–Q5) : Study the following information carefully and answer the given questions :**

Eight persons, viz S, T, U, V, W, X, Y and Z are sitting around a circular table facing the centre. Each of them has a different hobby, viz Singing, Acting, Dancing, Cycling, Swimming, Tracking, Painting and Reading, not necessarily in the same order. S, who likes reading, sits third to the left of W. The one who likes painting sits on the immediate right of S. V, who likes acting, sits second to the right of T. T is not on immediate neighbour of W. U, who likes dancing, sits exactly in the middle of the persons whom hobbies are swimming and painting. Y who likes singing, sits second to the left of Z, who likes tracking.

Q1. Which of the following pair represent the immediate neighbours of the person whose hobby is acting ?

- 1) T W 2) U Y 3) S Z 4) T Z 5) W Y

Q2. How many people sit between S and the person whose hobby is cycling when counted clockwise ?

- 1) None 2) One 3) Two 4) Three 5) Four

Q3. What is the position of T with respect to the position of the person whose hobby is swimming ?

- 1) Third to the left 2) Fourth to the right 3) Fifth to the left 4) Second to the right 5) Second to the left

Q4. Who exactly sits between Y and Z ?

- 1) S 2) T 3) U 4) V 5) W

Q5. Who sits on the immediate left of the X ?

- 1) T 2) U 3) V 4) S 5) None of these

## Reasoning Seating Arrangements Workbook

Q6. Whose hobby is tracking ?  
1) Z 2) X 3) U 4) T 5) None of these

**ANSWER –**

1. 3
2. 3
3. 4
4. 2
5. 4
6. 1

**SOLUTION –**

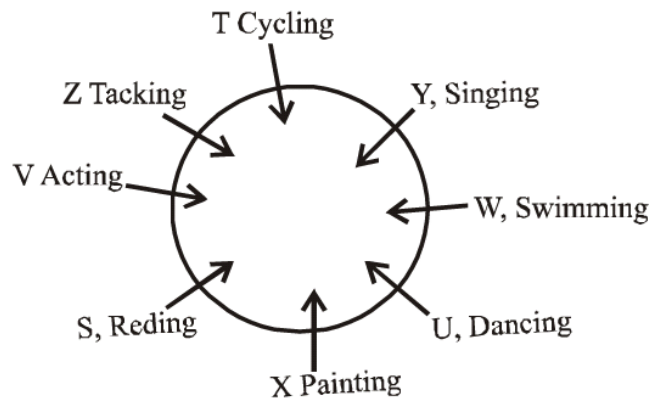

## SET – 5

**Directions (Q1–Q5): Study the following information and answer the questions given below:**

Eight politicians - Aakash, Bhuvan, Ravi, Digvijay, Ishwar, Firoj, Arind and Hitesh- are sitting around a circular table, facing the centre but not necessarily in the same order. Each of them win from a different assembly seats, viz. Laxmi Nagar, Sahadra, Chandni Chowk, Preet Vihar, Nirman Vihar, Tilak Nagar Lajpat Nagar and Dawarka. Aakash sits third to the right of the person who wins from Dawarka. The politician who wins from Chandni chowk and Lajpat Nagar are immediate neighbours. Only two politicians sits between the winner of Dawarka seat and Hitesh. Neither Aakash nor Hitesh won from Chandni Chownk and Lajpat Nagar Seats, The politicians who wins from Lajpat Nagar seat is not an immediate neighbour of the politician who wins from Dawarka seat. The winner of Laxmi Nagar seat sits second to the left of Ishwar. Ishwar is not an immediate neighbour of Hitesh. The winner of Laxmi Nagar seat is an immediate neighbour of both Nirman Vihar seats winner and Preet Vihar seats winner. The winner of Nirman Vihar seat sits third to the right of Bhuvan. Bhuvan do not win from Lajpat Nagar seat. Ravi sits on the immediate right of the winner from Sahadra seat. Aakash do not win from Sahadra. Firoj is not an immediate neighbour of Aakash. Arvind is not an immediate neighbour of the winner from the Laxmi Nagar seat.

Q1. Four of the following five are alike in a certain way based on the given arrangement and thus form a group. Which is the one that does not belong to the group?

- 1) Firoj- Sahadra 2) Arvind - Tilak Nagar 3) Digvijay - Laxmi Nagar 4) Aakash - Nirman Vihar 5) Bhuvan - Dawarka

## Reasoning Seating Arrangements Workbook

Q2. Who among the following sits third to the left of Ishwar?

1) Hitesh 2) Aakash 3) Digvijay 4) Arvind 5) Bhuvan

Q3. Who among the following is the winner of Tilak Nagar seat?

1) Aakash 2) Ravi 3) Hitesh 4) Arvind 5) Digvijay

Q4. Which seat does Bhuvan win from?

1) Sahadra 2) Laxmi Nagar 3) Preet Vihar 4) Chandni Chowk 5) None of these

Q5. Who sits on the immediate left of politician who wins from Dawarka seat?

1) Ravi 2) Firoj 3) Bhuvan 4) Hitesh 5) Ishwar

**ANSWER –**

1. 5

2. 3

3. 1

4. 4

5. 5

**SOLUTION –**

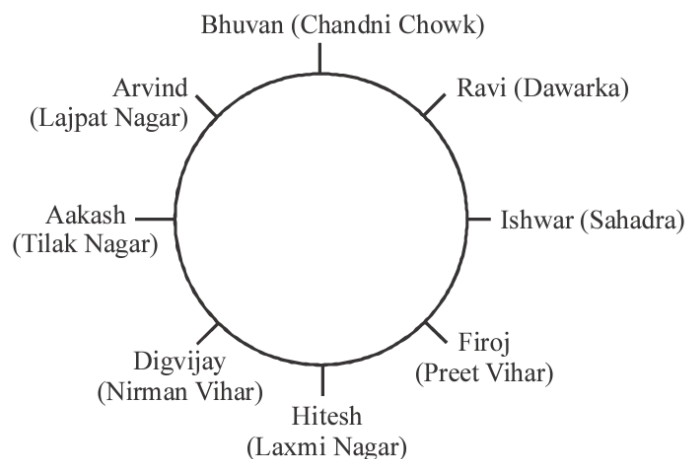

## **SET – 6**

**Directions (Q1–Q5):** Read the following information carefully to answer the given question.

In an International mobile event, eight representatives, viz E, F, G, H, I, J, K and L are representing different companies, viz Samsung, L.G., Sony, Apple, HTC, Motorola, Nokia, and Blackberry, but not necessarily in the same order. All of them are sitting around a circular table facing the centre. J sits third to the left of I. The representative of Apple and L. G are immediate neighbours of each other. G represents neither HTC nor Apple. G and L's immediate neighbours do not represent Sony. Only one person sits between E and the one who represents Motorola. E does not represent either Sony or L.G. Only one person sits between K and the representative of Sony. G sits third to the right of L. L represents Blackberry. I is not an immediate neighbour of either G or L. The one who represents Samsung is an immediate neighbour of I. Three people sit between L and the representative of Nokia. F is not representing either Sony or Samsung. G does not represent LG..

## Reasoning Seating Arrangements Workbook

Q1. Who among them represent L.G. ?

1) F 2) G 3) I 4) J 5) None of these

Q2. Who among the following represent immediate neighbours of J ?

1) G, F 2) E, H 3) I, K 4) E, G 5) K, E

Q3. How many person sits between H and the representative of Apple in anti-clockwise direction ?

1) One 2) Two 3) Three 4) Four 5) None of these

Q4. Which of the following pair is correct ?

1) E, L.G. 2) G, Nokia 3) H, Blackberry 4) K, Samsung 5) I, Sony

Q5. Which of the following is true regarding K ?

1) K sits second to the right of E 2) K represent Nokia 3) K sits between H and I

4) Only one person sits between K and J 5) None of these

**ANSWER –**

1. 4

2. 4

3. 2

4. 5

5. 5

**SOLUTION –**

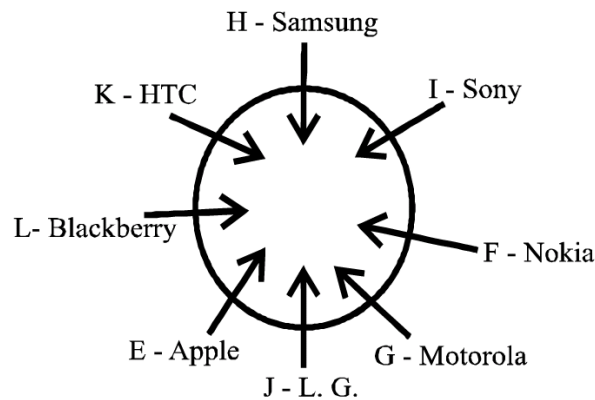

### **SET – 7**

**Directions (Q1–Q4): Study the following information and answer the following questions:**

J, K, L, M, N, O and P are sitting around a circular table facing the centre. M is not an immediate neighbour of O and is second to the right of N, who is second to the right of K. L is third to the right of P and second to the left of J.



## Reasoning Seating Arrangements Workbook

Q1. Who is second to the left of P ?

- 1) K 2) L 3) M 4) J 5) N

Q2. What is the position of O with respect to M ?

- 1) Third to the right 2) Third to the left 3) Second to the left 4) Second to the right 5) None of these

Q3. Who is sitting between L and J ?

- 1) P 2) M 3) O 4) N 5) K

Q4. In the following group, identify the one in which the first person is sitting between the second and third ?

- 1) K L N 2) J M P 3) O K P 4) N J M 5) O K L

**ANSWER –**

1. 4

2. 4

3. 4

4. 3

**SOLUTION -**

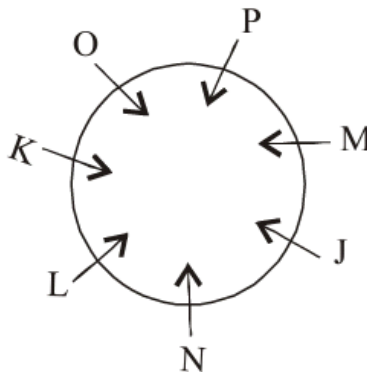

## **SET – 8**

**Directions (Q1–Q5): Study the following information carefully and answer the questions given below :**

Four Maruti Suzuki's cars - Ertigo, Celerio, Swift and Wagon'r and four Hyundai's cars - I-10, Verna, I-20 and Santa Fe are on a display in a circular auto expo centre. Two Maruti Suzuki's cars and two Hyundai's cars are not facing the centre of the auto expo centre. Swift is placed second to the left of Verna, which is not placed immediate next to Celerio. I-10 is third to the left of Santa Fe and one of them is not facing centre of the auto expo centre. Ertigo is third to the right of Celerio, Which is facing the centre of the auto expo centre. I-20 and Wagon'r are facing each other and both are not placed immediate next to Celerio or Santa Fe. No three Hyundai's car's are placed together.

Q1. Which of the following Car is placed between Celerio and Wagon'r ?

- 1) Swift 2) Verna 3) Santa Fe 4) I - 10 5) None of these

Q2. How many cars are placed between I-10 and Verna ?

## Reasoning Seating Arrangements Workbook

1) Three 2) Two 3) One 4) Can't be determined 5) None of these

Q3. Which Car is displayed third to the left of Ertigo ?

1) Celerio 2) Wagon'r 3) I-20 4) I-10 5) None of these

Q4. Which of the following groups of four Cars are not facing the centre ?

1) Swift, Wagon'r, Ertigo and Verna 2) Verna, I-10, Ertigo and Wagon'r  
3) Ertigo, Verna, I-10 and Swift 4) I-20, I-10, Santa Fe and Celerio 5) None of these

Q5. Who is placed between I-20 and Santa Fe ?

1) I-10 2) Ertigo 3) Swift 4) Verna 5) None of these

**ANSWER –**

1. 1

2. 1

3. 2

4. 3

5. 2

**SOLUTION –**

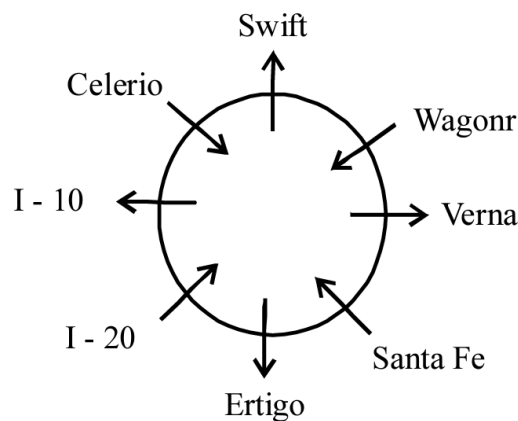

## **SET – 9**

**Directions (Q1–Q5): Study the following information carefully to answer the given questions.**

Six students P, Q, R, S, T & U is sitting around a circular table facing towards the centre of the table in a public library. They read different books -History, Physics, Chemistry, Biology, English and Hindi. They carry different colours of bags - Black, Red, Blue, Green, violet and Brown, but not necessarily in the same order. The students who read History, Chemistry and English books are having neither black nor red bag. The students who have blue and violet bag do not read History or Chemistry books. P do not have black bag and he is not on the immediate left of the student who read Biology. The only student who is between T and U reads physics. The student, who is on the left side of the student, who has black bag, does not read Hindi book. S reads biology book and the colour of his bag is blue also he is facing the student who reads physics book. One who reads history book is seated opposite to the student having Brown bag .The student whose bag is of blue colour is on the left of the student who reads English book. One who reads Hindi book is on the immediate right of the student, who has black

## Reasoning Seating Arrangements Workbook

bag but on the immediate left of the student, who reads Chemistry. R does not read chemistry and U does not read History book.

Q1. Who among the following reads English book?

1) T 2) P 3) R 4) U 5) Q

Q2. Which of the following pairs is the correct match?

1) P-History-Violet bag 2) R-Physics-Green bag 3) Q-Hindi-Red bag 4) R-Physics-Black bag 5) None of these

Q3. Which among the following book does U reads?

1) Hindi 2) English 3) History 4) Physics 5) Chemistry

Q4. The colour of the bag of the student, who read history book, is-

1) Red 2) Blue 3) Green 4) Black 5) Violet

Q5. The only student, who is between S and T, is having bag of the colour

1) Red 2) Black 3) Blue 4) Green 5) Violet

**ANSWER -**

1. 2
2. 4
3. 1
4. 3
5. 5

**SOLUTION –**

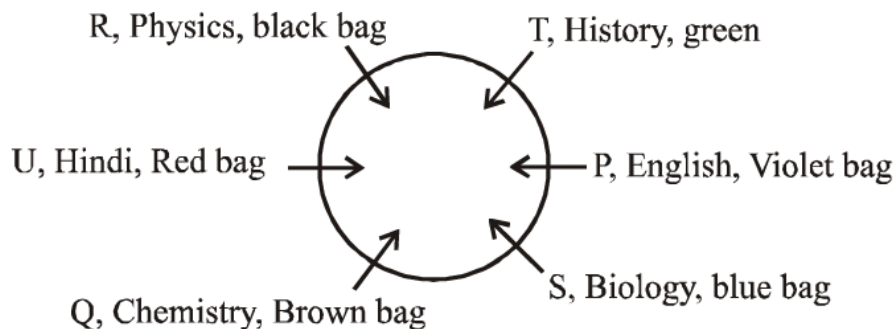

## SET – 10

**Directions (Q1–Q5): Study the following information and answer the following questions:**

There are seven different shops -UCB, Woodland, Reebok, Shoppers stop, Pantaloons, Blackberry and Adidas- with in the boundaries of a circular market. Only three shops are facing inside the market and rest are facing outside the market. Shoppers stop is between Blackberry and the shop which is facing inside the market and shoppers stop is to the immediate right of Blackberry. Pantaloon is second to the

## Reasoning Seating Arrangements Workbook

left of Adidas. Woodland is fourth to the right of UCB and both are facing same direction. A shop which is facing inside the market is on the immediate right of the shop which is facing outside and third to the right of woodland. Reebok and UCB are facing inside and are not immediate neighbours. Reebok is immediate right of Pantaloon

Q1. Which of the following have entrance from inside?

1) Adidas 2) Pantaloon 3) Shoppers stop 4) UCB 5) None of these

Q2. Which of the following shops is on the immediate right of Reebok?

1) Woodland 2) Pantaloon 3) Blackberry 4) UCB 5) Can't be determined

Q3. If shoppers stop and UCB interchange their positions, which of the following shops will be second to the left of Pantaloon?

1) UCB 2) Blackberry 3) Adidas 4) Reebok 5) None of these

Q4. Which of the following shops is between Adidas and Woodland in clockwise direction?

1) Pantaloon and Reebok 2) Reebok and UCB 3) Blackberry and Shopper stop 4) Reebok and Adidas 5) None of these

Q5. How many shops are there between Pantaloon & shoppers stop, which entrance from inside?

1) One 2) Two 3) Three 4) Can't be determine 5) None of these

**ANSWER –**

1. 4

2. 2

3. 1

4. 1

5. 1

**SOLUTION –**

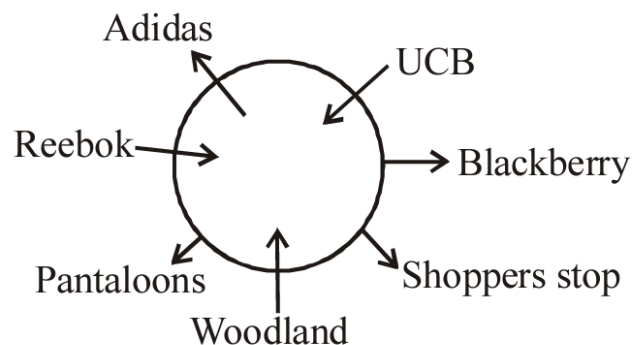

### **SET – 11**

**Directions (Q1–Q6): Study the following information and answer question given below:**

## Reasoning Seating Arrangements Workbook

---

Eight friends M, N, O, P, Q, R, S and T are sitting around a circular table facing the centre. Each of them read a different newspaper. viz, Times of India, The Hindu, Hindustan, Amar Ujala, Danik Bhaskar, Economic Times, Danik Jagran and Hindustan Times, but not necessarily in the same order. M and O, who reads Hindustan, can never sit together. There are two persons between the persons who reads Danik Jagran and Danik Bhaskar and the latter is to the left of Danik Jagran. The person who reads Danik Bhaskar sits second to the right of R. There are two person sitting between O and the person who reads Economic Times. N and Q are immediate neighbours of each other. The person who read Times of India sits on the immediate left of the person who reads Hindustan Times. T does not read Danik Jagran, Times of India or the Hindu and he is also not an immediate neighbour of the one who reads Economic Times. The person who reads Times of India cannot sit with the person who reads Amar Ujala. M is second to the right of the person who reads Danik Jagran. P neither reads Economic Times nor Danik Jagran. Q and S are not immediate neighbours. S, who does not read Danik Bhaskar sits on the immediate right of T. There is only one person between those two person who reads Hindustan Times and Economic Times. There is only one person sitting between S and the person who reads Economic times and the person who can never be R.

Q1. Who is second to the right of P?

- 1) O 2) T 3) S 4) Q 5) N

Q2. Who reads Times of India?

- 1) M 2) R 3) Q 4) O 5) P

Q3. What is the position of S with respect to the person who reads Amar Ujala?

- 1) Immediate left 2) Second to the right 3) third to the left 4) third to the right 5) immediate right

Q4. Which of the following pair is correct?

- 1) O, Hindustan Times 2) R, Hindustan 3) Q, Economic Times 4) N, Danik Bhaskar 5) P, Danik Jagran

Q5. Who among them immediate neighbours?

- 1) R and O 2) Q and S 3) T and N 4) Q and R 5) O and S

Q6. Which newspaper does T likes to read ?

- 1) Times of India 2) Danik Jagran 3) Danik Bhaskar 4) Amar Ujala 5) Hindu

**ANSWER –**

1. 3

2. 1

3. 5

4. 3

5. 1

6. 4

**SOLUTION –**

## Reasoning Seating Arrangements Workbook

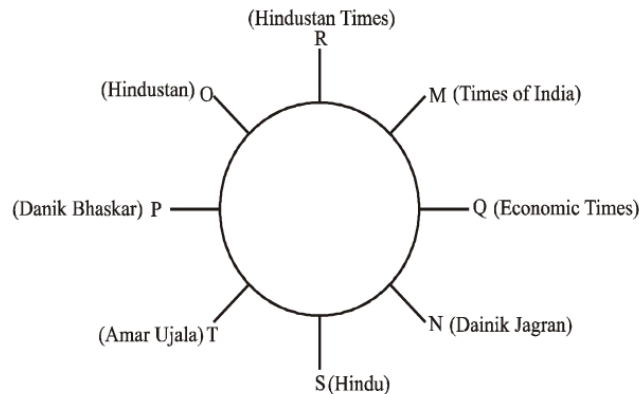

### **SET – 12**

**Directions (Q1–Q5):** Study the given information carefully and answer the question that follows : Arvind, Bhaskar, Ravi, Sachin, Tarun, Manoj, Ramesh are eight friends, each of them wears a different colour of shirt viz Red, Blue, Black, Purple, Pink, White, Brown and Yellow, but not necessarily in same order. All of them are seated around a circular table facing the centre. Arvind, who wears black shirt, sits third to the left of Tarun. The one who wears brown shirt, sits second to the right of Sachin. Sachin, who wear pink shirt, sits second to the right of Bhaskar, who is not immediate neighbour of Tarun. Ravi, who wears blue shirt, sits between the person who wears white and Brown shirts. Ramesh wears yellow and sits second to the left of Neeraj, who wears Red shirt.

- Q1. Who among the following pairs represent immediate neighbours of the person wearing pink shirt ?  
1) Neeraj and Sachin 2) Arvind and Manoj 3) Manoj and Neeraj 4) Arvind and Neeraj 5) None of these
- Q2. What is the position of Bhaskar with respect to the person wearing white shirt ?  
1) Fourth to the right 2) Third to the left 3) Second to the right 4) Fourth to the left 5) Second to the left
- Q3. How many persons are sitting between Arvind and the one who wears purple shirt, if counted clockwise?  
1) One 2) Two 3) Three 4) Four 5) Six
- Q4. Which of the following shirt does Manoj wears ?  
1) Blue 2) Brown 3) White 4) Red 5) None of these
- Q5. The one who sits between the person wears yellow and Red shirts ?  
1) Bhaskar 2) Tarun 3) Sachin 4) Neeraj 5) None of these

#### **ANSWER –**

1. 4
2. 3
3. 2
4. 2
5. 1

#### **SOLUTION –**

## Reasoning Seating Arrangements Workbook

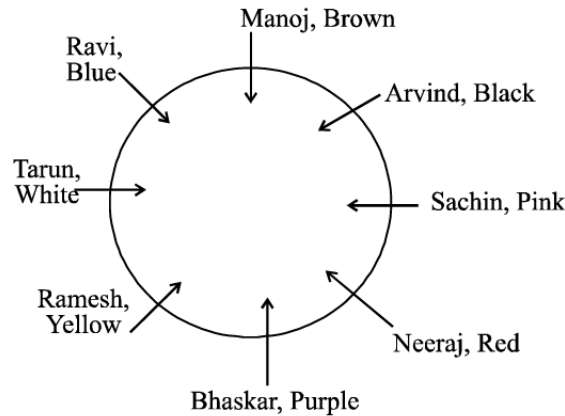

### SET – 13

**Directions (Q1–Q5):** Study the following information carefully and answer the given questions.

Eight friends Q, R, S, T, V, W, Y and Z are sitting around a circular table, facing the centre. There are three males and five females in the group of friends. No two males are immediate neighbours of each other.

V sits second to the right of his wife.

S sits third to the right of V.

W sits second to the right of her husband Z. Z is not an immediate neighbour of V's wife.

T is a male and Y is not an immediate neighbour of V.

R sits second to the right of Q.

Q1. Who amongst the following has a male sitting to the immediate left and the right?

1) Y 2) R 3) Q 4) S 5) None of these

Q2. Which of the following is not true regarding T?

1) T is an immediate neighbour of Z's wife.

2) No male is an immediate neighbour of T.

3) Q sits second to right of T.

4) The one who sits third to the left of T is a male.

5) All are true

Q3. Which of the following pairs represents the immediate neighbours of T ?

1) RQ 2) WZ 3) YV 4) WY 5) None of these

Q4. How many people sit between V and S when counted in anti-clockwise direction ?

1) Four 2) One 3) Two 4) Three 5) None

Q5. Who amongst the following sits exactly between V and Y?

1) Q 2) W 3) R 4) T 5) Z

**ANSWER –**

1. 2

2. 5

3. 4

4. 3

5. 1

**SOLUTION –**

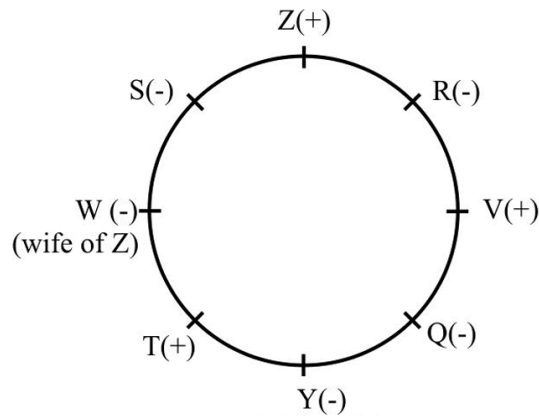

## **SET – 14**

**Directions (Q1–Q3):- Study the following information carefully and answer the given question :**

P, Q, R, S, T, U, V and W are sitting around a circle, facing the centre. U sits to the immediate right of S and third to the left of P. V sits third to the left of S who does not sit next to T. Q sits next to V but not next to S. R does not sit next to either S or P.

Q1. Who sits to the immediate left of P ?

1) T 2) U 3) V 4) W 5) None of these

Q2. What is the position of W with respect to R ?

1) Second to the left 2) First to the right 3) Third to the right 4) Second to the right 5) None of these

Q3. Which of the following pairs sits between S and V ?

1) P R 2) U W 3) W Q 4) U P 5) None of these

**ANSWER –**

1. 1

2. 5

3. 3

**SOLUTION –**



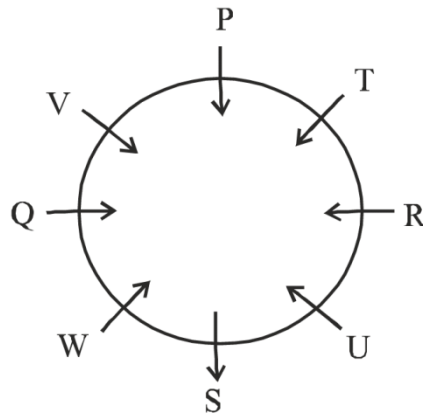

**SET – 15**

**Directions (Q1–Q5): Study the following information carefully and answer the questions given below :**

Eight persons, A, B, C, D, E, F, G and H, are sitting around a rectangular table in such a way that two persons sit on each of the four sides of the table facing the centre. Persons sitting on opposite sides are exactly opposite to each other. D faces North and sits exactly opposite H. E is on the immediate left of H. A and G sit on the same side. G is exactly opposite B, who is on the immediate right of C. A is next to the left of D.

Q1. Who is sitting opposite A?

- 1) G 2) D 3) E 4) A 5) None of these

Q2. Who is next to E in clockwise direction?

- 1) G 2) B 3) F 4) A or F 5) None of these

Q3. Which of the following pairs of persons has both the persons sitting on the same side with first person sitting to the right of second person?

- 1) DF 2) CB 3) FC 4) AG 5) None of these

Q4. Who is sitting opposite E?

- 1) D 2) A 3) F 4) A or D 5) None of these

Q5. Which of the following statements is definitely true?

- 1) A is facing North. 2) E is sitting opposite F. 3) F is to the left of G. 4) C is to the left of A. 5) None of these

**ANSWER –**

- 1. 5
- 2. 2
- 3. 4
- 4. 3

## Reasoning Seating Arrangements Workbook

5. 2

**SOLUTION –**

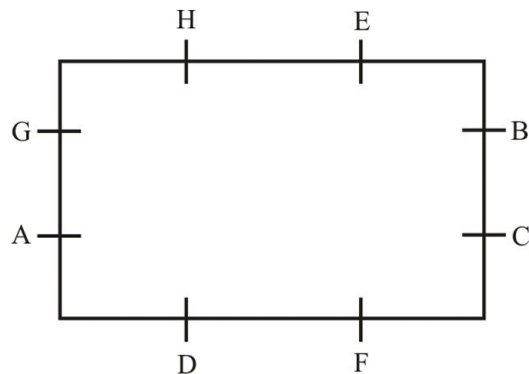

### **SET – 16**

**Directions (Q1–Q5): Study the following information carefully and answer the given questions.**

In an international meet, representatives A, B, C, D, E, F, G and H from eight different countries, viz Thailand, France, Holland, Austria, US, Spain, India and Germany (not necessarily in the same order), sit around a circular table facing the centre. A, who represents Germany, sits third to the left of E. The one who is from India sits on the immediate right of A. D, who is from Holland, sits second to the right of B. B is not an immediate neighbour of E. C, who is from Spain, sits exactly in the middle of people representing US and India. G, the representative from France, sits second to the left of H, who is from Thailand.

Q1. How many people sit between A and the representative from Austria when counted in clockwise directions?

- 1) None 2) One 3) Two 4) Three 5) Four

Q2. Which of the following is TRUE regarding representative F?

- 1) F is the representative of Austria.  
2) F sits second to the left of the representative from Thailand.  
3) The representative from Germany is not an immediate neighbour of F.  
4) E sits third to the right of F.  
5) None of these

Q3. In which of the following pairs is the representative from the first country sitting on the immediate left of the representative from the second country?

- 1) India-Thailand 2) Austria-US 3) Thailand-Holland 4) Spain-Germany 5) US-Spain

Q4. What is the position of B with respect to the position of the representative from the US?

- 1) Third to the left 2) Fourth to the right 3) Fourth to the left 4) Second to the right 5) Second to the left

Q5. Which of the following pairs represents the immediate neighbours of the representative from Holland?

- 1) CG 2) BE 3) AH 4) HB 5) GE

**ANSWER –**

## Reasoning Seating Arrangements Workbook

- 3
- 5
- 3
- 4
- 3

**SOLUTION –**

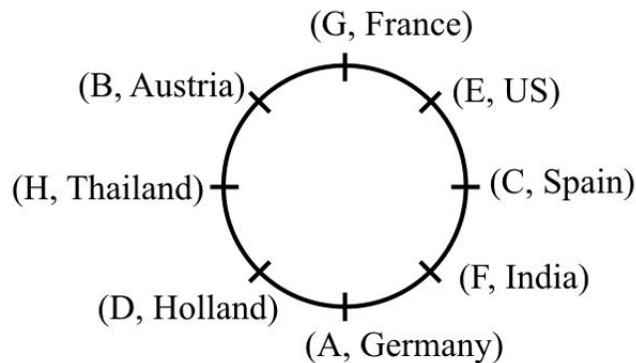

### **SET – 17**

**Directions (Q1–Q5):** Read the following information carefully and answer the questions:

In an UN summit representatives M, N, O, P, Q, R, S and T from eight different countries - Argentina, Japan, Italy, Vietnam, Australia, India, Brazil and France (not necessarily in the same order) sits around a square table facing the centre. M, who represents France sits third to the left of Q. The one who is from Brazil sits to the immediate right of M. P who is from Italy sits second to the right of N. N is not a neighbour of Q. O who is from India sits exactly in the middle of the people representing Australia and Brazil. S, who is the representative of Japan sits second to the left of T who is from Argentina.

Q1. The representative from which of the following countries sits exactly in the middle of the representatives from Argentina and Japan?

- 1) Brazil
- 2) Vietnam
- 3) Australia
- 4) France
- 5) None of these

Q2. The representative from which of the following countries is seated third to the right of the Italian representative?

- 1) India
- 2) Japan
- 3) Australia
- 4) Vietnam
- 5) None of these

Q3. How many people sit between M and the representative from Japan when counted in clockwise direction?

- 1) One
- 2) Two
- 3) Three
- 4) Four
- 5) None of these

Q4. Which of the following statement is true regarding representative R?

- 1) R is the representative of Japan
- 2) R is between the representatives of Italy and Japan
- 3) R sits to the immediate left of M
- 4) R sits third to the right of S
- 5) None of these

## Reasoning Seating Arrangements Workbook

Q5. Which of the following is correct?

- 1) N is from Japan
- 2) S is immediately left of the representative of Australia
- 3) O is between Q and representative of Japan
- 4) P is representative of Italy
- 5) None of these

**ANSWER –**

1. 2
2. 1
3. 3
4. 5
5. 4

**SOLUTION –**

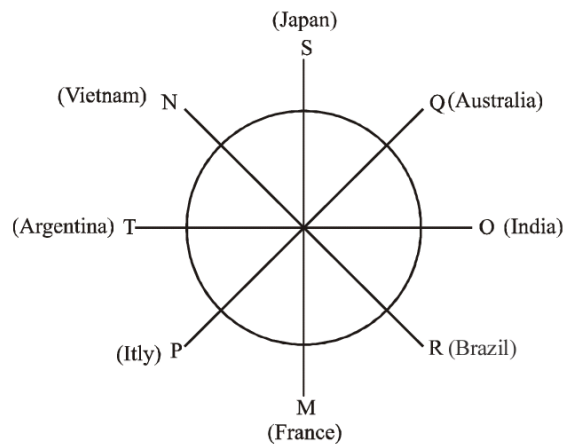

## **SET – 18**

**Directions (Q1–Q5):** Study the following information carefully and answer the questions given below:

A, B, C, D, E, F, G and H are the eight members in a family, they all are sitting around a rectangular table for dinner. There is only one members sitting in each shorter side of the rectangle. B and C are in opposite side and facing diagonally each other. H is not in front of E, who is on the immediate left of G. H, who is facing F is sit second to the right of A. F is not in the shorter side of the table and cannot be an immediate neighbour of C.

Q1. Who is on the immediate right of G?

- 1) F
- 2) B
- 3) H
- 4) C
- 5) A

Q2. Who among the following is sitting between B and D?

- 1) G
- 2) F
- 3) A
- 4) C
- 5) H

## Reasoning Seating Arrangements Workbook

Q3. What position of D with respect to H?

1) Immediate left 2) Second to the left 3) Third to the left 4) Immediate right 5) Second to the right

Q4. Which among the following pair represents the immediate neighbour of A?

1) C, H 2) C, D 3) F, D 4) E, H 5) B, F

Q5. Who among the following is exactly between C and E?

1) H 2) F 3) A 4) G 5) B

**ANSWER –**

1. 2

2. 2

3. 3

4. 2

5. 1

**SOLUTION –**

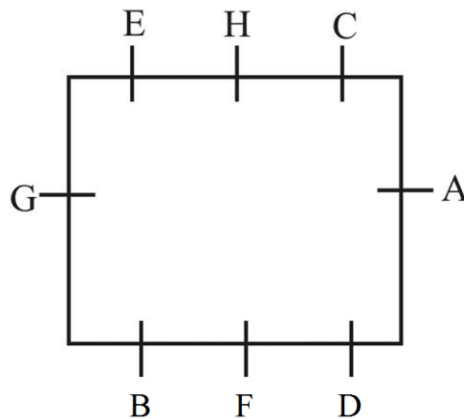

## SET – 19

**Directions (Q1–Q5):** Study the following information carefully and answer the questions given below:

D, E, F, G, H, I, J and K are sitting around a square table in such a way that four of them sit at four corners of the square and facing the centre while four sit in the middle of each of the four sides but not facing the centre. D sits third to the right of I, who is not facing the centre. H is not an immediate neighbour of I and D. There are only one person between I and J. G is second to the right of E, who is immediate left of J. F is not immediate neighbour of D.

Q1. Who among the following sits opposite to H?

1) E 2) D 3) J 4) Either 1 or 3 5) Other than given options

Q2. What is the position of E with respect to K?

## Reasoning Seating Arrangements Workbook

1) Fourth to the right 2) Third to the right 3) Third to the left 4) Second to the left 5) Other than given options

Q3. Four of the following five are alike in a certain way hence form a group. Which is the one that does not belong to that group?

1) KD 2) EJ 3) GI 4) HF 5) DK

Q4. If F is second to the left of I, then who among the following is third to the right of J?

1) H 2) K 3) E 4) Cannot be determined 5) Other than given options

Q5. Who among the following sits exactly between J and K?

1) E 2) D 3) H 4) F 5) Other than given options

**ANSWER –**

1. 4
2. 3
3. 4
4. 1
5. 2

**SOLUTION –**

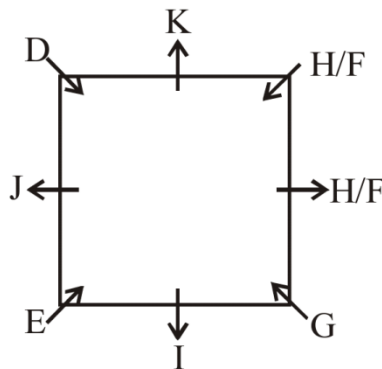

### **SET – 20**

**Directions (Q1–Q5):** Study the following information carefully and answer the questions given below:

G, H, I, J, K, L, M and N are sitting in a row facing north. M does not sit extreme ends of the row. L sits either sixth from the left end of the row or third from the right end of the row but sits fourth to the right of G. J sits second to the right of I, who is not an immediate neighbour of L. K and H are immediate neighbours of each other but neither of them sit extreme ends of the row. Only one person sits between K and M.

## Reasoning Seating Arrangements Workbook

---

Q1. What is the position of H with respect to G?

1) Second to the right 2) Third to the right 3) Immediate left 4) Fourth to the left 5) Other than given options

Q2. If I is related to H and J is related to L in a certain way, to which of the following would K be related to following the same pattern?

1) G 2) H 3) M 4) N 5) Other than given options

Q3. Which of the following pairs sit extreme ends of the row?

1) LG 2) IN 3) IJ 4) Cannot be determined 5) Other than given options

Q4. How many persons are there between K and I?

1) Two 2) None 3) Three 4) Four 5) Other than given options

Q5. Who among the following sit exactly between the person who sits second from the right and the person who sits fifth from the left end?

1) K 2) J 3) L 4) M 5) Other than given options

**ANSWER –**

1. 1
2. 4
3. 2
4. 3
5. 3

**SOLUTION –**

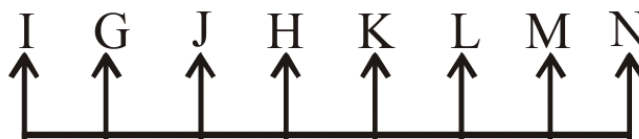

### **SET – 21**

**Directions (Q1–Q4):** Study the following information carefully and answer the questions given below:

A, B, C, D, E, F, G, H eight people read in class 1st, 2nd, 3rd, 4th, 5th, 6th, 7th, 8th. All they sit around a circular table faces towards centre. C sits third to the right of H. H, reads in class 8th. F is left to the second of E. E is not neighbour of C and H. Who reads in class 1st is neighbour of E. Three people sit between H and who reads in class 7th. Nor H, nor C and nor their neighbour read in class 2nd. Between

## Reasoning Seating Arrangements Workbook

class of 2nd and G one person is sitting. Class 3rd and 4th person are neighbours. C is not in class 4th and 3rd. Between A and Class 5th is one person. A does not read in class 3rd and 2nd. Also B is not in class 2nd.

Q1. Who reads in class 6th?

1) G 2) D 3) C 4) B 5) E

Q2. Who is the neighbour of C and read in class 3rd?

1) A 2) F 3) G 4) D 5) B

Q3. Who is 2nd to the right of one who reads in class 5th?

1) D 2) A 3) G 4) B 5) Other than given options

Q4. How many persons between the one who reads in class 6th and the one who reads in class 3rd?

1) Two 2) Three 3) Four 4) Five 5) One

**ANSWER –**

1. 5

2. 5

3. 1

4. 5

**SOLUTION –**

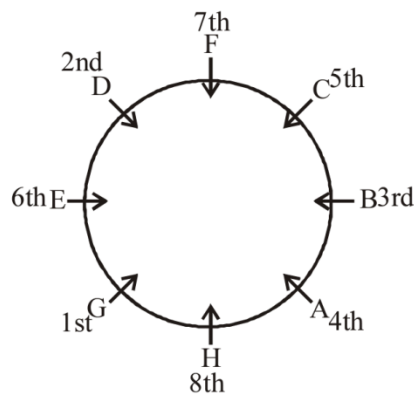

### **SET – 22**

**Directions (Q1–Q5):** Study the following information carefully and answer the questions given below:

Four boys Pushkar, Mohan, Chandan and Rohan and four girls Elli, Soni, Heena and Antika are sitting around a circular table. Two boys and two girls are not facing the centre of the table. No three girls are sitting together. Chandan is second to the left of Soni, who is not sitting next to Mohan. Elli is not facing the centre. Pushkar is third to the right of Mohan, who is facing the centre. Heena and Rohan are



## Reasoning Seating Arrangements Workbook

facing each-other and both are not sitting next to Mohan or Antika. Heena is immediate right of Pushkar, who is on immediate left of Ankita.

Q1. Who among the following is sitting between Mohan and Rohan?

1) Pushkar 2) Antika 3) Chandan 4) Heena 5) Other than given options

Q2. How many boys sits between Soni and Elli (if counted from Elli in clockwise direction)?

1) Three 2) Two 3) One 4) Can't be determined 5) Other than given options

Q3. Who is sitting third to the left of Pushkar?

1) Rohan 2) Elli 3) Mohan 4) Antika 5) Heena

Q4. Which of the following groups of four people are not facing the centre?

1) Chandan, Rohan, Soni and Pushkar

2) Elli, Soni, Pushkar and Rohan

3) Pushkar, Soni, Elli and Chandan

4) Pushkar, Chandan, Antika and Soni

5) Other than given options

Q5. Who is sitting between Heena and Antika?

1) Elli 2) Soni 3) Pushkar 4) Mohan 5) Other than given options

**ANSWER –**

1. 3

2. 1

3. 1

4. 3

5. 3

**SOLUTION –**

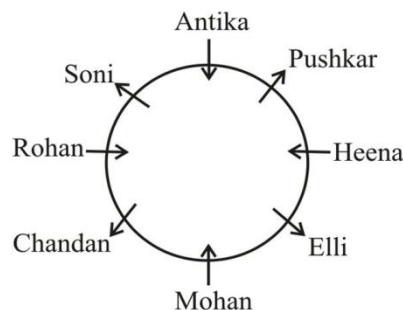

**SET – 23**

## Reasoning Seating Arrangements Workbook

---

**Directions (Q1–Q5):** Study the following information carefully and answer the questions given below:

Twelve persons are sitting in two parallel lines in such a way that there are six persons in each row at equidistance. A, B, C, D, E and F are sitting in row-1 and they face towards east. P, Q, R, S, T and V are sitting in row-2 and they face towards west. One person of one row faces the other person of the other row.

P, who is sitting at one of the ends of the row, is second to the right of T. A does not face P or T. A is third to the left of F. There are two persons between Q and V. There is only one person between C and D. C and D do not face P. B is neighbour of C. S, who does not face D, is not the neighbour of Q.

Q1. Who among the following faces F ?

- 1) Q 2) T 3) S 4) R 5) V

Q2. How many persons are sitting between E and C ?

- 1) One 2) Two 3) Three 4) Four 5) None

Q3. E is related to R in the same way as B is related to S. On this pattern F is related to

- 1) V 2) P 3) T 4) Q 5) None of these

Q4. Which of the following statements is true about B?

- 1) Q is the neighbour of that person who faces B  
2) C is not the immediate neighbour of B  
3) E is second to the right of B  
4) T faces B  
5) B is second from the left end of the row

Q5. Who are sitting at the ends of the row?

- 1) P, V 2) F, A 3) D, E 4) P, S 5) None

**ANSWER -**

- 1.5  
2.2  
3.4  
4.4  
5.3

**SOLUTION -**

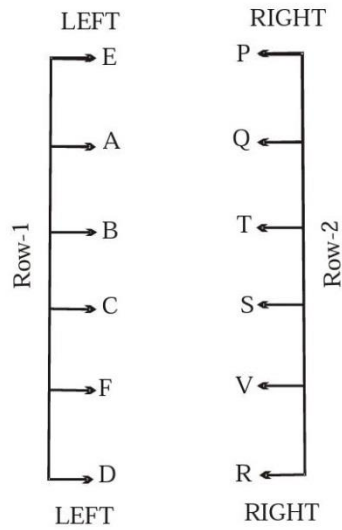

## SET – 24

**Directions (Q1–Q6):** Study the following information carefully and answer the questions given below:

K, L, M, P, Q, R, S, T are sitting around a square table in such a way that four of them sit at four corner of the square while four sit in the middle of each side of the four side. The one who sit at the four corner face outside while those who sit in the middle of the sides face the center of the Table.

P sits third to the right of S. S faces the centre. Q sits third to the left of M. M does not sit in the middle of the sides. Only one person sits between Q and R. R is not an immediate neighbour of M. T faces the centre. K is not an immediate neighbour of R.

Q1. What is position of M with respect to L ?

- 1) Third to the right
- 2) M and L sit diagonally opposite to each other
- 3) Second to the right
- 4) Second to the left
- 5) Fifth to the right

Q2. Who sits exactly between Q and R?

- 1) T 2) P 3) K 4) M 5) S and K

Q3. Which of the following pairs represents the persons seated in the middle of the sides who face each other?

- 1) S, Q 2) K, L 3) M, P 4) R, T 5) T, Q

Q4. Who amongst the following sit between R and K when counted in anticlockwise direction from K?

- 1) No one sits between R and K as R and K are immediate neighbours of each other

## Reasoning Seating Arrangements Workbook

- 2) S, P and L
- 3) P and Q
- 4) L and R
- 5) M, S and T

Q5. If K is made to face the opposite direction, who would sit to his immediate right?

- 1) R 2) Q 3) P 4) T 5) S

Q6. Four of the following five are alike in a certain way and so form a group. Which is the one that does not belong to that group?

- 1) L 2) M 3) K 4) P 5) R

**ANSWER -**

- 1.4
- 2.2
- 3.5
- 4.3
- 5.2
- 6.5

**SOLUTION –**

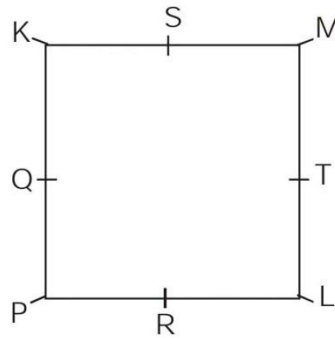

### **SET – 25**

**Directions (Q1–Q5):** Study the following information carefully and answer the questions given below:

Eight people S, R, N, L, M, T, O and P are sitting in a circle facing the centre. All eight belong to different professions — reporter, doctor, cricketer, teacher, accountant, shopkeeper, painter and supervisor. They are not necessarily seated in the mentioned order.

## Reasoning Seating Arrangements Workbook

---

M is sitting third to the left of O. The doctor is to the immediate right of M and M is not a reporter. R is sitting fourth to the right of P. Neither R nor P is an immediate neighbour of M. T is a teacher and is sitting third to the right of the doctor. The shopkeeper is sitting second to the left of the teacher. The painter is sitting second to the left of M. S the cricketer is sitting exactly between T and P. The accountant is sitting second to the right of the cricketer. N is sitting third to the left of T.

Q1. Who amongst the following is a reporter ?

- 1) O 2) L 3) N 4) R 5) None of these

Q2. What is S's position with respect to R?

- 1) Third to the right 2) Second to the right 3) Third to the left 4) Second to the left 5) Fourth to the right

Q3. How many people are sitting between P and N when counted in an anticlockwise direction from N ?

- 1) One 2) Two 3) Three 4) Four 5) None

Q4. Four of the following five pairs are alike in a certain way based on their positions in the above arrangement and so form a group. Which of the following does not belong to the group ?

- 1) Teacher - Painter 2) Supervisor – Shopkeeper 3) Cricketer - Reporter 4) Doctor - Accountant  
5) Shopkeeper - Doctor

Q5. Which one of the following statements is false according to the above mentioned arrangement?

- 1) N is to the immediate right of the supervisor  
2) The cricketer is third to the right of the shopkeeper  
3) The doctor is sitting exactly between the supervisor and the accountant  
4) L is neither a teacher nor a supervisor  
5) There are only three people between S and N

**ANSWER -**

- 1.1  
2.1  
3.4  
4.5  
5.3

**SOLUTION -**

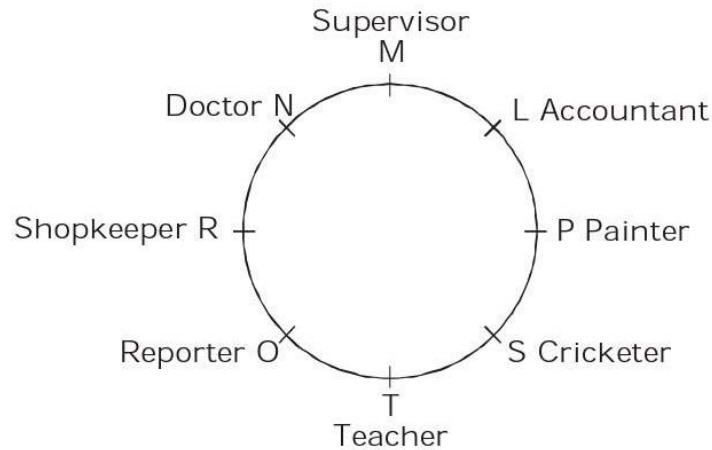

## SET – 26

**Directions (Q1–Q5):** Study the following information carefully and answer the questions given below:

Twelve people are sitting in two parallel rows containing six people each, in such a way that there is an equal distance between adjacent persons. In row-1 P, Q, R, S, T and V are seated and all of them are facing South. In row-2 A, B, C, D, E and F are seated and all of them are facing North. Therefore, in the given seating arrangement each member seated in a row faces another member of the other row. P sits third to the left of T. Neither P nor T sits at an extreme end of the line. A sits second to the right of E. Neither A nor E faces T or P. A does not sit at an extreme end. R does not face A and R does not sit at an extreme end of the line. Only one person sits between F and C. Neither F nor C faces T. C does not sit at the extreme end. Only one person sits between V and Q. F is not an immediate neighbour of B and A does not face V.

Q1. How many persons are seated between B and D?

- 1) One 2) Two 3) Three 4) Four 5) None

Q2. V is related to B in the same way as Q is related to C. To which of the following is P related to, following the same pattern?

- 1) F 2) A 3) D 4) E 5) None of these

Q3. Which of the following is true regarding V?

- 1) V faces A  
 2) T is not an immediate neighbour of V.  
 3) C faces the one who is second to left of V  
 4) V sits at one of the extreme ends of the line  
 5) R sits third to the right of V

Q4. Who amongst the following sit at extreme ends of the rows?

- 1) D, F 2) V, S 3) Q, S 4) B, D 5) None of these

## Reasoning Seating Arrangements Workbook

---

Q5. Who amongst the following faces B?

1) V 2) S 3) Q 4) R 5) T

**ANSWER –**

1.2

2.1

3.4

4.2

5.5

**SOLUTION –**

