

**RBI GRADE B 2018: PHASE I MEMORY
BASED PAPER**

GENERAL AWARENESS

1. Pitch Black Military Exercise was held in which of the following countries?

- a. Japan
- b. Russia
- c. America
- d. Canada
- e. Australia**

2. Peace Mission military exercise is held by

- a. Japan
- b. Russia**
- c. America
- d. Canada
- e. Australia

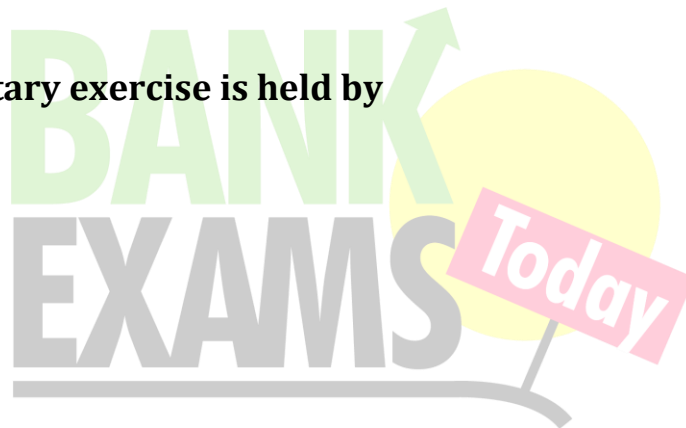

3. Who is the first Chief Financial Officer of RBI?

- a. Sugandha Balakrishnan
- b. Sunitha Balakrishnan
- c. Suman Balakrishnan
- d. Sudha Balakrishnan**
- e. None of the above

4. Where is the All Prime Minister Museum to be located?

- a. Teen Murti Bhavan**
- b. Banga Bhavan
- c. Bharatiya Vidya Bhavan
- d. KG Marg

e. None of these

5. What does the S stand for in BIMSTEC?

- a. Social
- b. Sectional
- c. Suspension
- d. Sectoral**
- e. Supersede

6. Which of the following is the fifth nation to join BRICS?

- a. Brazil
- b. Russia
- c. China
- d. India
- e. South Africa**

7. 10th BRICS Summit held in

- a. Fortaleza, Brazil
- b. Goa, India
- c. Johannesburg, South Africa**
- d. Xiamen, China
- e. None of the above

8. All India Institute of Ayurveda (AIIA) to be located in

- a. Ahmadabad
- b. Indore
- c. Goa
- d. Surat
- e. New Delhi**

9. Prime Minister Narendra Modi and Ugandan President Yoweri Museveni unveiled a bust of India's first home minister Sardar Vallabhbhai Patel at the Indian community event they addressed in

- a. Kisoro
- b. Masaka
- c. Masaka
- d. Mbarara
- e. Kampala**

10. Lusaka is the capital of

- a. Vanuatu
- b. Laos
- c. Zambia**
- d. Serbia
- e. Estonia

11. Shanghai Cooperation Organisation (SCO) will be held in the Qingdao, a city of

- a. China**
- b. Russia
- c. Japan
- d. South Korea
- e. Indonesia

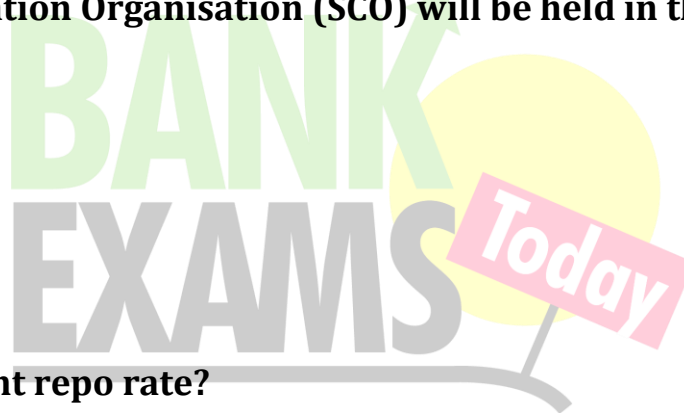

12. What is the current repo rate?

- a. 6.25%
- b. 6.50%**
- c. 6%
- d. 6.75
- e. None of the above

13. Golden Glove award 2018 was conferred to

- a. Bruno Appels
- b. Patrick Aussems
- c. Maurice Blieck
- d. Danny Boffin
- e. Thibaut Courtois**

14. PhonePe is launched by

- a. Google
- b. Amazon
- c. Snapdeal
- d. Paytm
- e. Flipkart**

15. Social Pay service which enables Non-Resident Indians (NRIs) to send money to beneficiaries in India using social media apps such as WhatsApp and e-mail was launched by

- a. ICICI Bank**
- b. IDFC Bank
- c. HDFC Bank
- d. IDBI Bank
- e. None of the above

16. Truncated Cheques come under which of the following acts?

- a. The Banking Regulation Act, 1949
- b. Reserve Bank of India Act, 1934
- c. Negotiable Instruments Act, 1881**
- d. The Industrial Disputes (Banking and Insurance Companies) Act-1949
- e. None of the above

17. Under FRDI Bill, bail-in clause will affect

- a. defaulters
- b. withdrawers
- c. Depositors**
- d. All of the above
- e. None of the above

18. In the Public Affairs Index 2018, which state topped the list third time?

- a. Karnataka
- b. Kerala**

- c. Gujarat
- d. Maharashtra
- e. Andhra Pradesh

19. Which of the following states witnessed a substantial increase in inflow from \$2.1 billion in the financial year 2016-17 to \$8.6 billion in the financial year 2017-18, registering a growth of more than 300%, according to an analysis by Care Ratings?

- a. Karnataka**
- b. Kerala
- c. Gujarat
- d. Maharashtra
- e. Andhra Pradesh

20. Mascot of Tokyo Olympics 2020 is

- a. Miraitowa**
- b. Bhin Bhin
- c. Patrick
- d. Juanito
- e. Pique

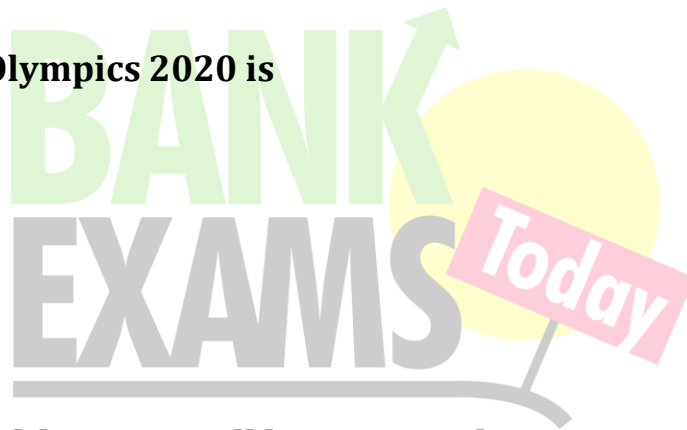

21. 2022 Commonwealth Games will be organized in

- a. Hamilton, Canada
- b. Kingston, Jamaica
- c. Sydney, Australia
- d. Birmingham, England**
- e. Edinburgh, Scotland

22. M. A. Chidambaram Stadium is located in

- a. Mumbai
- b. Chennai**
- c. Indore
- d. Jaipur
- e. Dharamshala

23. Hirakud Dam is located in which of the following states?

- a. West Bengal
- b. Jharkhand
- c. Uttar Pradesh
- d. Odisha**
- e. None of the above

24. Kunchikall Waterfall is in located in which of the following states?

- a. Karnataka**
- b. Kerala
- c. Maharashtra
- d. Telangana
- e. None of the above

25. Haldia Refinery is in located in which of the following states?

- a. Jharkhand
- b. Odisha
- c. West Bengal**
- d. Arunachal Pradesh
- e. None of the above

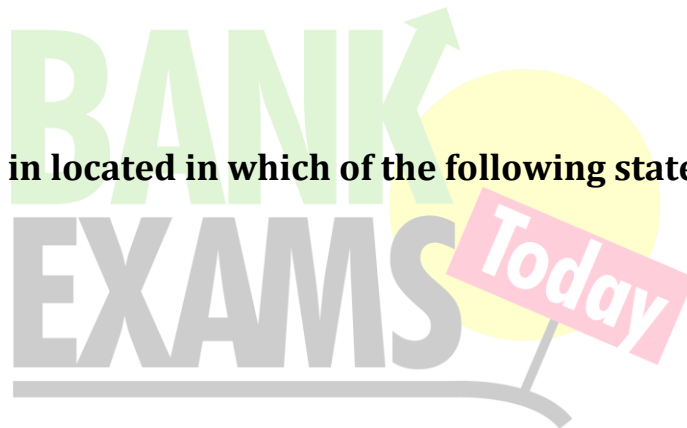

26. Under Marginal Standing Facility, banks take the loan from

- a. Asian Development Bank
- b. International Monetary Fund
- c. Citizens of India
- d. Central Government of India
- e. Reserve Bank of India**

27. Walmart partnered with which of the following companies for Digital Boost in India?

- a. Flipkart
- b. Amazon

- c. Google
- d. Microsoft**
- e. Wipro

28. Nokrek National Park is located in which of the following states of India?

- a. Mizoram
- b. Meghalaya**
- c. Karnataka
- d. Kerala
- e. None of the above

29. Gangtok is the capital of

- a. Sikkim**
- b. Assam
- c. Meghalaya
- d. Mizoram
- e. Nagaland

30. TIES Scheme launched by Ministry of Commerce & Industry is related to

- a. Import Substitute
- b. Employment
- c. Export**
- d. Technology in Import
- e. Other than the above

31. Pratyush is set up in which of the following organizations?

- a. IITM Pune**
- b. IITM Mumbai
- c. IITM Indore
- d. IITM Jaipur
- e. IITM Chandigarh

32. What does R stand for in IRAC ?

- a. Reconstruction
- b. Relationship
- c. Regulation
- d. Resemblance
- e. Rule**

33. When group lenders provide money to the borrower, this type of loan is called?

- a. Syndicated Loan**
- b. Subsidized
- c. Commercial
- d. Payday Loans
- e. None of these

34. Ramsay Magsaysay Award 2018 was conferred to

- a. Aditya Patnaik and Girija Das
- b. Sudeep Waswani and Anuja Vyas
- c. Bharat Vatwani and Sonam Wangchuk**
- d. Bharat Vatwani and Girija Das
- e. None of the above

35. Sukanaya Samridhi Yojana was launched in which year?

- a. 2014
- b. 2015**
- c. 2016
- d. 2017
- e. 2018

36. Minimum amount for Sukanaya Samridhi Yojana

- a. 1100 INR
- b. 1000 INR
- c. 500 INR
- d. 225 INR
- e. 250 INR**

37. Head Quarter of Jena Small Finance Bank is located in

- a. Bengaluru
- b. Mumbai
- c. New Delhi
- d. Kolkata
- e. Chennai

38. Head Quarter of Corporation bank is located in

- a. Mumbai
- b. Mangalore**
- c. New Delhi
- d. Kolkata
- e. Chennai

39. Head Quarter of IDFC is in

- a. Mumbai
- b. Mangalore
- c. New Delhi
- d. Kolkata
- e. Chennai

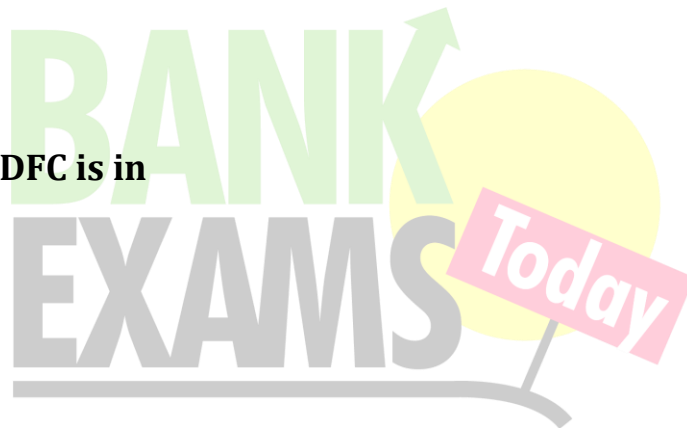

40. Who among the following received the Dada Saheb Phalke Lifetime Achievement Award 2018 ?

- a. Anupam Kher
- b. Dilip Kumar
- c. Amitabh Bachchan
- d. Lata Mangeshkar
- e. Simi Grewal**

41. Why I am Hindu Book is authored by

- a. Shashi Tharoor**
- b. Yogi Adityanath

- c. Narendra Modi
- d. Sushma Swaraj
- e. None of the above

42. Rani ki Vav is located in

- a. Himachal Pradesh
- b. Uttrakhand
- c. Rajasthan
- d. Maharashtra
- e. Gujarat**

43. Centre Government set up a high-powered four-member committee to examine, and to deliberate on the need for a separate law to curb lynching and mob violence, the panel, headed by

- a. Rajnath Singh
- b. Rajiv Gauba**
- c. Sushma Swaraj
- d. Nirmala Sitharaman
- e. Other than the above

44. A banking outlet which does not provide delivery of service for a minimum of _____ per day and for at least 5 days a week will be considered a 'Part-time Banking Outlet'

- a. 4 hours**
- b. 6 hours
- c. 5 hours
- d. 7 hours
- e. 8 hours

45. Under the Fugitive Economic Offenders Bill, what is the minimum amount to file a case?

- a. 100 crore**
- b. 500 crore
- c. 250 crore

- d. 150 crore
- e. 200 crore

46. Section 22 of Banking Regulation Act deals with

- a. Accounts and balance-sheet
- b. Interest charged by banking companies
- c. Licensing of banking companies**
- d. Power of Reserve Bank
- e. Restriction on acceptance of deposits

47. What connects Mediterranean sea and Red Sea

- a. Bruges Canal
- b. Suez Canal**
- c. Canal de Castilla
- d. Seton Canal
- e. Nan Madol

48. Sabarimala Sastha Temple is located in which state of India?

- a. Tamil Nadu.
- b. Andhra Pradesh
- c. Karnataka
- d. Kerala**
- e. Telangana

49. Moon Jae-in is the president of

- a. Philiphines
- b. Singapore
- c. Japan
- d. China
- e. South Korea**

50. Who among the following Spanish footballer retired from soccer after Football World Cup 2018?

a. **Andres Iniesta**

b. Iker Casillas

c. Sergio Ramos

d. Juan Mata

e. Jordi Alba

51. Fakhar Zaman the fastest batsman to score 1000 ODI runs belongs to which country?

a. India

b. Afghanistan

c. **Pakistan**

d. Australia

e. America

52. Headquarter of ICAN is located in

a. **Australia**

b. Germany

c. India

d. France

e. UK

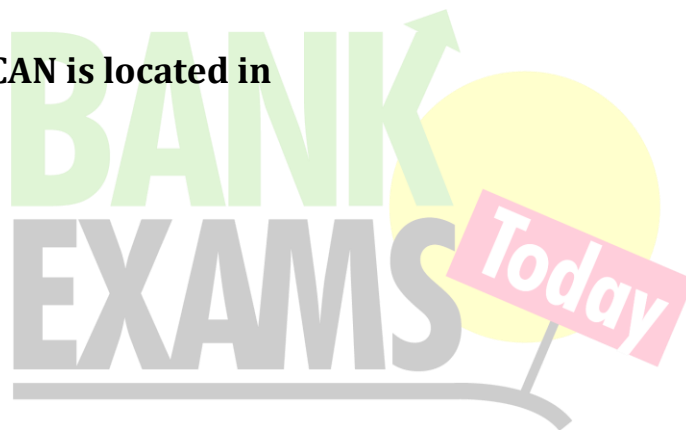

53. AIFF Player of the year 2018 award was conferred to

a. Eugeneson Lyngdoh

b. **Sunil Chhetri**

c. Syed Rahim Nabi

d. Jo Paul Ancheri

e. Bhaichung Bhutia

54. Payment banks cannot perform which of the following functions?

a. cannot issue debit cards

b. **cannot issue credit cards**

c. accounts cannot be intergrated with savings bank accounts.

d. a and b both

e. a and c both

55. September 8 is observed as

- a. National Technology Day
- b. World Heritage Day
- c. World Day of Social Justice
- d. National Youth Day
- e. International Literacy Day**

56. What does W stand for in WLTS in computer terminology?

- a. Wireless**
- b. Wired
- c. Web
- d. Wined
- e. None of the above

57. Shubhankar Sharma is associated with which of the following sport?

- a. Shooting
- b. Golf**
- c. Snooker
- d. Table Tennis
- e. Football

58. Bansagar Dam project is a joint venture between which of these three states?

- a. Madhya Pradesh, Uttar Pradesh, Bihar**
- b. Madhya Pradesh, Uttar Pradesh, Rajasthan
- c. Madhya Pradesh, Chhattisgarh, Jharkhand
- d. Jharkhand, Bihar, Uttar Pradesh
- e. None of the above is correct

59. Which organ in human body regenerates itself?

- a. Cornea
- b. Intestines**

- c. Pancreas
- d. Liver**
- e. None of the above

60. Head Quarter of Arab League is located in

- a. Cairo, Egypt**
- b. Beirut, Lebanon
- c. Manama, Bahrain
- d. Sana'a, Yemen
- e. None of the above

61. Who is the Head of the Committee formed to tackle NPAs in India?

- a. Sangeet Kedia
- b. Sudeep Kataria
- c. Sunil Mehta**
- d. Sanjeev Sharma
- e. None of the above

62. Rohingya tribe belong to which state of India?

- a. Sikkim
- b. Meghalaya
- c. Mizoram
- d. Myanmar**
- e. Tripura

63. What is the current Statutory Liquidity Ratio?

- a. 18.25%
- b. 18.50%
- c. 19.75%
- d. 19.25%
- e. 19.50%**

64. Which of the following countries was the host of 2018 World Environment Day?

- a. Canada
- b. India**
- c. Brazil
- d. Denmark
- e. France

65. MSME day in India is observed on

- a. 20 June
- b. 22 June
- c. 25 June
- d. 27 June**
- e. 29 June

66. Head of Committee set up by RBI to make a Public Credit Registry (PCR) is

- a. Rajeev Nair
- b. Rashid Akram
- c. Y.M. Deosthalee**
- d. Pratush Desai
- e. None of the above

67. Hima Das belongs to which state of the following states?

- a. Sikkim
- b. Meghalaya
- c. Assam**
- d. Myanmar
- e. Tripura

68. Headquarter of Asian Infrastructure Investment Bank is located in

- a. Kathmandu, Nepal
- b. Beijing, China**
- c. Manila, Philippines
- d. Bangkok, Thailand
- e. Malé, Maldives

69. RBI's Financial Literacy Week starts from

- a. February 14
- b. July 8
- c. October 10
- d. September 7
- e. June 4**

70. First nuclear bomb was dropped in

- a. Kyoto
- b. Yokohama
- c. Osaka
- d. Hiroshima**
- e. Sapporo

71. The headquarter of Interpol is located in which countries?

- a. Egypt
- b. Canada
- c. United States of America
- d. Russia
- e. France**

72. Which of the following bank listed as Best bank (2018) in private sector?

- a. Axis bank.
- b. HDFC Bank**
- c. ICICI Bank
- d. Indusind bank
- e. Federal bank

73. Jallikattu is typically practiced in

- a. Tamil Nadu**
- b. Karnataka
- c. Andhra Pradesh
- d. Telangana

e. Kerala

74. Which engine has been developed and used by ISRO

- a. b. CE-21 cryogenic rocket engine
- b. CE-20 cryogenic rocket engine**
- c. b. CE-22 cryogenic rocket engine
- d. b. CE-211 cryogenic rocket engine
- e. b. CE-210 cryogenic rocket engine

75.. “Banglore Tiger” Book is based on which of the following company?

- a. Tata
- b. Paytm
- c. Tata
- d. Wipro**
- e. Reliance

76. Who is known as the Metro man of India

- a. P. Sreedharan
- b. N. Sreedharan
- c. K. Sreedharan
- d. R. Sreedharan
- e. E. Sreedharan**

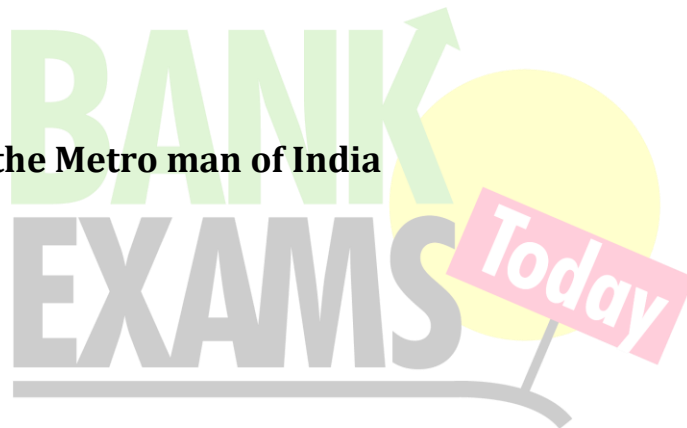

78. India's first heritage city is

- a. Jaisalmer
- b. Jaipur
- c. Ahmedabad**
- d. Surat
- e. Anand

78. “Our Tree is Still Grown in Dehra” is written by which of the following authors?

- a. Durjoy Datta
- b. Jhumpa Lahiri
- c. Salman Rushdie

d. Ruskin Bond

e. Shashi Tharoor

79. Which bank is to provide Financial and Digital Literacy to farmers across Rajasthan and Haryana

a. Yes Bank

b. HDFC Bank

c. IDFC Bank

d. ICICI Bank

e. IBDI Bank

80. Where is Salar Jung Museum located?

a. Shimla

b. Mumbai

c. Jaipur

d. Indore

e. Hyderabad

QUANTITATIVE APTITUDE

Directions: Following is a tabulation of Number of ODI Cricket Matches Played, won, lost and drawn by five different countries in the year 2016 with some missing data. Read the table carefully and answer the questions.

Country Name	Total No. of Matches Played	No. of Matches Won	No. of Matches Lost	No. of Matches Draw
Australia	-	-	43	12
India	-	100	44	-
Pakistan	150	90	-	-
South Africa	162	-	47	-
Sri Lanka	-	80	-	-

Q:81: How many countries has won more than 100 matches, if the total number of matches won by all the country is 475 and total number of matches played by Australia is twice as match won by Srilanka?

- a) None
- b) One
- c) Two
- d) Three
- e) None of these

Solution: Option B

- a) By observing the table, we can predict the answer as either One or Two.
 Total no. of matches played by Australia = 2 * match won by Srilanka
 = 2*80 = 160
 No. of matches won by Australia = 160 - (43+12) = 105 (> 100)
 Total no. of matches won by South Africa = 475 - (105+100+90+80)
 = 100 (not greater than 100)
 Only Australia has won more than 100 matches, so the answer is one.

Q: 82: What is the number of matches draw by Srilanka, if the ratio between matches won by India and Australia to the number of matches played by South Africa and Srilanka is 6:7 and the ratio between number of matches played by Australia and Pakistan to number of matches lost by South Africa and Srilanka is 3:1, given that number of matches lost by Srilanka is twice the number of matches lost by India?

- a) 15
- b) 18
- c) 20
- d) Data Insufficient
- e) None of these

Solution : Option C

Let matches won by Australia be x
 Let matches played by Srilanka be y

$$\frac{\text{Matches Won by India and Australia}}{\text{Matches played by South Africa and Srilanka}} = \frac{100+x}{162+y} = \frac{6}{7}$$

$$7(100 + x) = 6(162 + y)$$

$$700 + 7x = 972 + 6y$$

$$7x - 6y = 972 - 700$$

$$7x - 6y = 272 \text{ -----(1)}$$

Let the matches played by Australia be z

Matches lost by Srilanka = $2 \times 44 = 88$

$$\frac{\text{Matches played by Australia and Pakistan}}{\text{Matches lost by South Africa and Srilanka}} = \frac{z+150}{47+88} = \frac{3}{1}$$

$$z+150 = 3(135)$$

$$z = 405 - 150 = 255 \text{ (matches played by Australia)}$$

$$\text{Matches won by Australia (x)} = z - (43 + 12) = 255 - (43 + 12) = 200$$

Sub x = 200 in eqn. (1)

$$7(200) - 6y = 272$$

$$1400 - 6y = 272$$

$$6y = 1128$$

$$y = 188 \text{ (matches played by Srilanka)}$$

$$\text{Therefore, matches draw by Srilanka} = 188 - (80 + 88) = 20 \text{ (ans)}$$

Q: 83: What is the total number of matches played by India, if the number of matches draw by India is 10% of the matches won by India?

- a) 154
- b) 155
- c) 164
- d) 165
- e) None of these

Solution: Option A

$$\text{No. of matches draw by India} = (10/100) * 100 = 10$$

$$\text{No. of matches Played by India} = 100 + 44 + 10 = 154 \text{ (ans)}$$

Q: 84: If Pakistan didn't lose any match, then what is the difference between the percentage of matches draw by Pakistan and percentage of matches lost by South Africa?

- a) 15
- b) 16

- c) 17
- d) Data Insufficient
- e) None of these

Solution : Option E

No. of matches draw by Pakistan = $150 - (90 + 0) = 60$
 % of matches draw by Pakistan = $(60/150) * 100 = 40\%$
 % of matches lost by South Africa = $(47/162) * 100 = 29\%$
 Difference = $40 - 29 = 11$ (ans)

Q: 85: If none of the match was draw by any of the country, then what will be the ratio between matches played by India, Pakistan and South Africa to number of matches lost by India, Pakistan and Australia?

- a) 155:49
- b) 155:52
- c) 153: 49
- d) 152:49
- e) None of these

Solution : Option D

Matches played by India = $100 + 44 = 144$
 Matches played by Pakistan = 150
 Matches played by South Africa = 162
 Matches lost by India = 44
 Matches lost by Pakistan = $150 - 90 = 60$
 Matches lost by Australia = 43

$$\frac{\text{Matches played by India, Pakistan \& S.Africa}}{\text{Matches lost by India, Pakistan \& Australia}} = \frac{144 + 150 + 162}{44 + 60 + 43} = \frac{456}{147} = \frac{152}{49} \text{ (ans)}$$

Directions: Go through the data set given below and solve the questions based on it.

The percentage wise break up of total players who play five different sports is shown in following pie chart.

Total Number of Players = 4200

Percentage of Players who play different sports

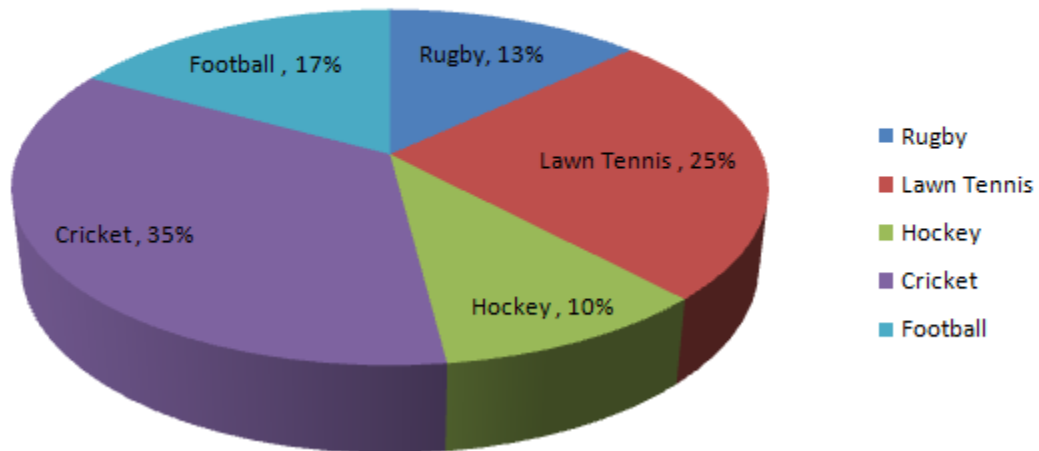

Female players is equal to 2000, out of 4200 players.

Break up of female players playing these five sports is shown in following pie chart.

Percentage of Female Players who play different sports

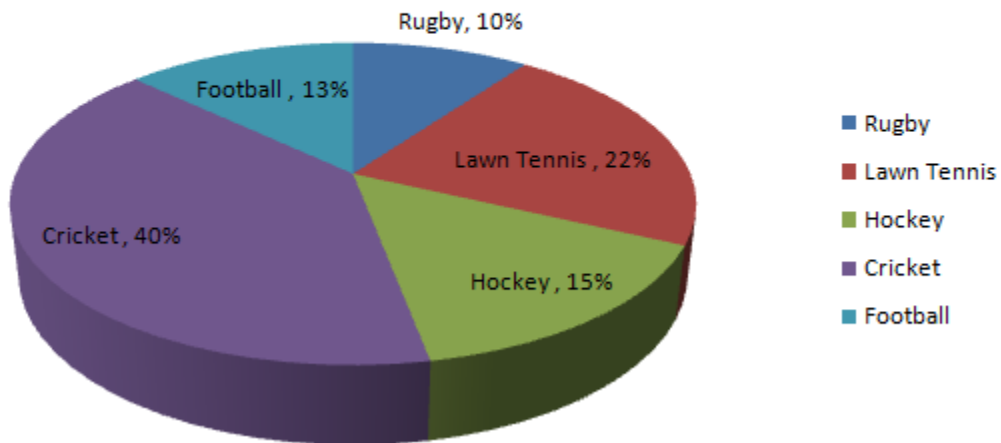

Q: 86. What is the number of total players who play football and rugby together?

- a) 1080
- b) 1160
- c) 1260
- d) 1210
- e) None of The Above

Answer: (Option C)

$$\begin{aligned} \text{Average number of players who play Football and Rugby} &= [(17 + 13) \% \text{ of } 4200] \\ &= 4200 \times \frac{30}{100} = 1260 \end{aligned}$$

Q: 87. What is the difference between the number of the female players who play lawn tennis and the number of male players who play rugby?

- a) 84
- b) 94
- c) 64
- d) 104
- e) None of The Above

Answer: (Option B)



$$\text{Number of Male players who play Rugby} = 4200 \times \frac{13}{100} = 546$$

$$\text{Number of Female players who play Rugby} = 2000 \times \frac{10}{100} = 200$$

$$\text{Hence, Number of Male players who play Rugby} = 546 - 200 = 346$$

$$\text{Number of Female players who play Lawn Tennis} = 2000 \times \frac{22}{100} = 440$$

$$\text{Hence, Required Difference} = 440 - 346 = 94$$

Q: 88. What is the respective ratio of the number of female players who play cricket and number of male players who play hockey?

- a) 20 : 7
- b) 4 : 21
- c) 20 : 3
- d) 3 : 20
- e) None of The Above

Answer: (Option C)

$$\text{Number of Female Cricketers} = 2000 \times \frac{40}{100} = 800$$

$$\begin{aligned}\text{Number of Male Hockey players} &= 4200 \times \frac{10}{100} - 2000 \times \frac{15}{100} \\ &= 420 - 300 = 120\end{aligned}$$

Hence Required Ratio = $800 : 120 = 20 : 3$

Q: 89. What is the total number of male players who play football, cricket and lawn tennis together?

- a) 1720
- b) 1734
- c) 1700
- d) 1834
- e) None of The Above

Answer: (Option B)

Number of Male players who play Football, Cricket and Lawn Tennis

$$= (17 + 35 + 25)\% \text{ of } 4200 - (13 + 40 + 22)\% \text{ of } 2000$$

$$= 4200 \times \frac{77}{100} - 2000 \times \frac{75}{100} = 3234 - 1500 = 1734$$

Q:90. Number of male players who play rugby is approximately what percentage of the total number of players who play lawn tennis?

- a) 23
- b) 33
- c) 43
- d) 53
- e) None of The Above

Answer (Option B)

$$\text{Number of Male players who play Rugby} = 4200 \times \frac{13}{100} - 200 = 346$$

$$\text{Number of Players who play Lawn Tennis} = 4200 \times \frac{25}{100} = 1050$$

$$\text{Hence Required Percentage} = \frac{346}{1050} \times 100 = 33$$

Directions: Based on the following passage, answer the questions which follow

A took a voluntary retirement on February 1st, 2014 and received 10 lakhs as retirement benefits. As on that day he also had Rs 3 lakhs in the bank. Of the total amount he had, 60% was invested in the bank which gives an annual compounded interest of 15%, for three years. Of the remaining part, half was invested in shares, which appreciated by 15% in the first year, 6% in the second year and depreciated by 10% the next year. The remaining part was invested in real estate. The real estate values increased by 10% in the first year, reduced by 10% in the next year and remained steady in the third year.

Q: 91. What was the value (in rupees lakhs) of A's investment on February 1st, 2015?

- a. 21 lakhs
- b. 14.82 lakhs
- c. 15.36 lakhs
- d. 15.97 lakhs
- e. None of these

Solution: b) Total amount 1st February 2014 = 10 + 3 = Rs 13 lakhs

Bank	Shares	Real estate
7.8 lakhs	2.6	2.6

For 1st year, value in bank will increase by 15%. So, total value will be 1.15 times of previous value. Hence, value after 1 year in bank = $7.8 \times 1.15 = 8.97$

For the first year, share value increases by 15%. Hence, value after 1 year in shares = $2.6 \times 1.15 = 2.99$

Similarly, Value after 1 year in real estate = $2.6 \times 1.1 = 2.86$

Total value in 2015 = Rs 14.82 lakhs.

Q: 92. What was the approximate value (in rupees lakhs) of his investment on 1st February 2017?

- a. 16.21 lakhs

- b. 16.82 lakhs
- c. 17.286 lakhs
- d. 17.87 lakhs
- e. None of these

Solution: Money in bank = $7.8 \times (1+0.5)^3 = 7.8 \times 1.52 = 11.86$ (use compound interest formula for three years)

For the first year, share value increases by 15%, for the second year it increases by 6% and for the third year it decreases by 10%. So, value of share at the end of three years is $2.6 \times 1.1 \times 1.06 \times 0.9 = 2.852$

Similarly, Value of real estate = $2.6 \times 1.1 \times 0.9 = 2.574$

Total value = 17.286

Q: 93. In which year did the investment show the maximum increase?

- a. First
- b. Second
- c. Third
- d. Both (A) and (C)
- e. None of these

Solution: Value of investment on 1st February 2014 = 13 lakhs

Value of investment on 1st February 2015 = 14.82 lakhs

Value of investment on 1st February 2016 = 16.063

Value of investment on 1st February 2017 = 17.286

It is clearly seen that maximum %increase is in 2015.

Direction: Each of the following questions has two statements. You have to decide whether data provided in the statements are sufficient to answer the question.

- A.** If the data in statement I alone are sufficient to answer the question, while the data in statement II alone is not sufficient to answer the question
- B.** If the data in statement II alone are sufficient to answer the question, while the data in statement I alone is not sufficient to answer the question
- C.** If the data either in Statement I alone or Statement II alone are sufficient to answer the question

- D.** If the data in both the statements I and II are not sufficient to answer the question
E. If the data in both the statement I and II are together necessary to answer the question.

Q: 94. What is the radius of the circle B?

Statement I: Diameter of circle A is 6 cm and Distance between center of circle A and B is 10 cm

Statement II: Difference between areas of both the circle is 16π

1. Option E

Solution : E) From statement I:

Diameter (circle A) = 6 cm

Radius (circle A) = $6/2 = 3$ cm

Distance between center of Circle A and B = 10 cm

From Statement II:

Difference between area of Circle A and B = 16π

$\pi (\text{radius of circle B})^2 - \pi (\text{radius of circle A})^2 = 16\pi$

$\pi (\text{radius of circle B})^2 - \pi(3)^2 = 16\pi$

$\pi (\text{radius of circle B})^2 = 16\pi + 9\pi = 25\pi$

Radius of circle B = $\sqrt{25} = 5$ cm

Therefore both statements are needed to find the answer

Q: 95. How is Ram related to Tarun?

Statement I: If Satheesh is only brother of Divya, who is the wife of Ram

Statement II: If Ramya is only daughter -in-law of Satheesh and Reijina is only sister of Tarun.

Solution : Option D

From statement I

Ram = Divya (brother) Satheesh

From Statement II

Ramya only daughter-in-law Satheesh

Reijina only sister Tarun

There is no direct relation between either Satheesh and Tarun or Satheesh and Reijina, so from both the statements we cannot obtain the answer.

Q: 96. Eight Friends (A, B, C, D, E, F, G and H) are sitting in a circle facing the center. Who is sitting 3rd to the right of B?

Statement I: D and E sit opposite to each other. Immediate neighbours of D are B and G.

Statement II: E sits 3rd to the left of B, who sits 2nd to the left of G, who sits opposite of H, who sits 3rd to the right of F.

Solution : Option B

From Statement I

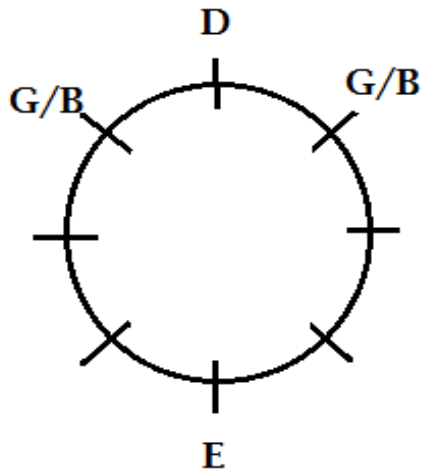

From Statement II

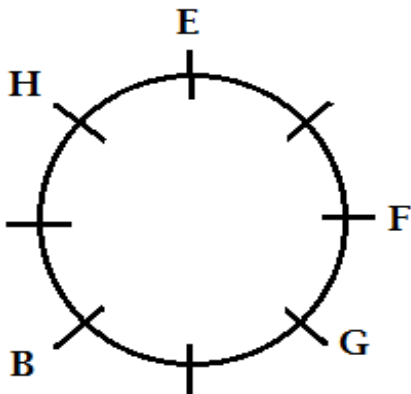

From the above diagram, 3rd to the right of B is F.

Therefore Statement II alone enough to answer the question

Q: 97. 'W' is in which direction from 'B'?

Statement I: A is to the north of X and south of W. F is to the north of B and east of W

Statement II: C is to the south-West of W. B is to the East of C. A is to the west of B.

Solution : Option A

From Statement I

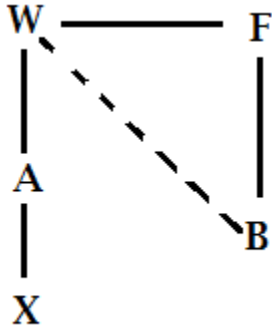

(North - West)

From Statement II

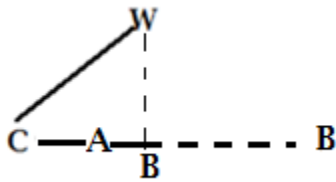

Here the direction of W from B differs according to the position of B
Therefore Statement I alone enough to obtain the answer

Q: 98. Is $X > Y$?

Statement I: $X > Z > B$; $Z \geq A \geq W$; $C < D < Y$

Statement II: $X < Z < B$; $Z < W < C$; $B = Y > W$

Solution: Option B

From Statement I There is no relation between X and Y

From Statement II $X < Z < W < Y$

$X < Y$

Answer is No.

Therefore Statement II alone enough to answer.

Q: 99: Sushil began a business with Rs. 85,000. he was joined afterwards by Rahul with Rs. 42,500. For how much period does Rahul join, If the profits at the end of the year are divided in the ratio of 3:1 ?

- (a) 4 months
- (b) 6 months
- (c) 8 months**
- (d) 5 months
- (e) 3 months

Solution:

4) Let Rahul join for x months

$$= \left(\frac{85000 \times 12}{42500 \times x} \right) = 3$$

$$X = \left(\frac{85000 \times 12}{42500 \times 3} \right) = 8$$

$$X = 8$$

Hence. Rahul joined for 8 months.

The correct answer is (c).

Q: 100: Ankush and Balwinder can do a piece of work in 18 days. Balwinder and Chinky can do it in 24 days. Ankush and Chinky can do it in 36 days. In how many days will Ankush, Balwinder and Chinky finish it, working together and separately?

- a) 144 days
- b) 405 days
- c) 169 days
- d) 691 days
- e) None of The Above

Solution :

(Ankush + Balwinder)'s 1 day's work = $\frac{1}{18}$

(Balwinder + Chinky)'s 1 day's work = $\frac{1}{24}$

(Ankush + Chinky)'s 1 day's work = $\frac{1}{36}$

Adding, we get: 2 (Ankush + Balwinder + Chinky)'s 1 day's work

$$= \frac{1}{18} + \frac{1}{24} + \frac{1}{36} = \frac{9}{72} = \frac{1}{8}$$

(Ankush + Balwinder + Chinky)'s 1 day's work = $\frac{1}{16}$

Thus Ankush, Balwinder and Chinky together can finish the work in 16 days

Now, Ankush's 1 day work

= [(Ankush + Balwinder + Chinky)'s 1 day work] - [(Balwinder + Chinky)'s 1 day's work]

$$= \frac{1}{16} - \frac{1}{24} = \frac{1}{48}$$

Ankush alone can finish the work in 48 days

Similarly, Balwinder's 1 day's work = $\frac{1}{16} - \frac{1}{36} = \frac{5}{144}$

Balwinder alone can finish the work in $\frac{144}{5} = 28\frac{4}{5}$

And Chinky's 1 day's work = $\frac{1}{16} - \frac{1}{18} = \frac{1}{144}$

Chinky alone can finish the work in 144 days.

Q: 101: A milkman has 80 liter mixture of milk and water which has 20% of water. The milkman sold some mixture and add 8 liter of water to the remaining mixture. Now the ratio of the milk and water is 12:5. Find the sold mixture.

- A. 5 Liter
- B. 20 Liter
- C. 16 Liter
- D. 4 Liter
- E. None of these

Solution: b)

In 80 liter mixture, Milk=64 liter, Water=16 Liter

Let milkmen sold X liter mixture, then

$$\frac{64 - x \times 80\%}{16 - x \times 20\% + 8} = \frac{12}{5}$$

$$5(64 - x \times 80\%) = 12(16 - x \times 20\% + 8)$$

$$5 \times 64 - x \times 80\% \times 5 = 12 \times 16 - x \times 20\% \times 12 + 12 \times 8$$

$$320 - x \times 400\% = 192 - x \times 240\% + 96$$

$$320 - 192 - 96 = x \times 400\% - x \times 240\%$$

$$32 = x \times 160\%$$

$$x = 20 \text{ Liter}$$

Q: 102: What should come at the place of question mark (?) in the following question?

$$33.5\% \text{ of } 420 - 47\% \text{ of } 500 = ? - 9.09\% \text{ of } 1331$$

A. 33.7

B. 27.7

C. 26.7

D. 28.7

E. 31.7

Ans. C.

Solution:

$$33.5\% \text{ of } 420 - 47\% \text{ of } 500 = ? - 9.09\% \text{ of } 1331$$

$$\frac{420 \times 33.5}{100} - \frac{500 \times 47}{100} = ? - \frac{1331 \times 9.09}{100}$$

$$\frac{210 \times 67}{100} - 235 = ? - 121$$

$$140.7 - 235 + 121 = ?$$

$$? = 261.7 - 235$$

$$? = 26.7$$



Q: 103: What should come at the place of question mark (?) in the following question?

$$(42)^2 \div (56)^2 \div \sqrt{324} = 2^{? - 2}$$

A. 2

B. 5

C. 3

D. -6

E. -3

Ans. E.**Solution:**

$$(42)^2 \div (56)^2 \div \sqrt{324} = 2^{?-2}$$

$$\frac{(7 \times 3 \times 2)^2}{(7 \times 8)^2 \times 18} = 2^{?-2}$$

$$\frac{9 \times 2^2}{(2^3)^2 \times 18} = 2^{?-2}$$

$$\frac{2^2}{2^6 \times 2} = 2^{?-2}$$

$$2^{(2-6-1)} = 2^{?-2}$$

$$2^{-5} = 2^{?-2}$$

$$? = -5 + 2$$

$$? = -3$$

Q: 104: What should come at the place of question mark (?) in the following question?

$$2\frac{3}{5} - 3\frac{7}{13} + 7\frac{6}{23} = ? - 1\frac{12}{65}$$

A. $7\frac{758}{1495}$

B. $5\frac{695}{1495}$

C. $4\frac{695}{2295}$

D. $5\frac{758}{2295}$

E. $6\frac{594}{2295}$

Ans. A.

Solution:

$$2\frac{3}{5} - 3\frac{7}{13} + 7\frac{6}{23} = ? - 1\frac{12}{65}$$

$$(2 - 3 + 7 + 1)\frac{3}{5} - \frac{7}{13} + \frac{6}{23} + \frac{12}{65} = ?$$

$$(10 - 3)\frac{897 - 805 + 390 + 276}{1495} = ?$$

$$7\frac{1563 - 805}{1495} = ?$$

$$7\frac{758}{1495}$$

Q: 105: What should come at the place of question mark (?) in the following question?

$$35 - \left[\frac{7}{9} + \left\{ \frac{5}{36} \left(\frac{1}{24} - \frac{5}{12} + \frac{3}{8} \right) \right\} \right] = ?$$

A. $31\frac{2}{9}$

B. $33\frac{2}{9}$

C. $37\frac{2}{9}$

D. $34\frac{2}{9}$

E. $38\frac{2}{9}$

Ans. D.

Solution:

$$35 - \left[\frac{7}{9} + \left\{ \frac{5}{36} \left(\frac{1}{24} - \frac{5}{12} + \frac{3}{8} \right) \right\} \right] = ?$$

$$35 - \left[\frac{7}{9} + \left\{ \frac{5}{36} \left(\frac{1-10+9}{24} \right) \right\} \right] = ?$$

$$35 - \left[\frac{7}{9} + \left\{ \frac{5}{36} \times 0 \right\} \right] = ?$$

$$35 - \frac{7}{9} = ?$$

$$\frac{315-7}{9} = ?$$

$$? = 308 \div 9 = 34 \frac{2}{9}$$

Q: 106: What should come at the place of question mark (?) in the following question?

$$\frac{4\frac{3}{5} - \frac{27}{40} \text{ of } \frac{20}{9}}{\sqrt{3136} + \sqrt{1936}} = ?$$

- A. 31
- B. .31
- C. .031
- D. .0031
- E. 3.1

Ans. C.

Solution:

$$\frac{4\frac{3}{5} - \frac{27}{40} \text{ of } \frac{20}{9}}{\sqrt{3136} + \sqrt{1936}} = ?$$

$$\frac{\frac{23}{5} - \frac{27}{40} \times \frac{20}{9}}{56 + 44} = ?$$

$$\frac{\frac{23}{5} - \frac{3}{2}}{100} = ?$$

$$\frac{46 - 15}{100} = ?$$

$$\frac{31}{1000} = ?$$

$$? = .031$$

Q: 107: John travelled from his town to city. John went to city by bicycle at the speed of 25 km/h and came back at the speed of 4 km/h. If John took 5 hours and 48 min to complete his journey, what is the distance between town and city ?

- 15 km
- 22 km
- 20 km
- 25 km
- None of the above

Answer : [C]**Explanation :**

⇒ Average speed of John = $\frac{2xy}{x+y} = \frac{2 \times 25 \times 4}{25 + 4} = \frac{200}{29}$ km/h

⇒ Distance traveled = Speed × Time = $\frac{200}{29} \times \frac{29}{5} = 40$ Km

⇒ Distance between city and town = $40/2 = 20$ km

Q: 108: Ram walks at a speed of 12 km/h. Today the day was very hot so walked at 5% of his average speed. He arrived his school 10 minutes late. Find the usual time he takes to cover the distance between his school and home?

- a. 40 mins
- b. 45 mins
- c. 50 mins
- d. 60 mins
- e. None of the above

Answer : [C]

Explanation :

- ⇒ If Ram is walking at $\frac{5}{6}$ of his usual speed that means he is taking $\frac{6}{5}$ of using time.
- ⇒ $\frac{6}{5}$ of usual time - usual time = 10 mins
- ⇒ $\frac{1}{5}$ of usual time = 10 mins
- ⇒ Usual time = 50 mins

Q:109: In a mixture of 40 litres, the ratio of milk and water is 4:1. How much water must be added to this mixture so that the ratio of milk and water becomes 2:3.

- (a) 20 litres
- (b) 32 litres
- (c) 40 litres
- (d) 30 litres
- (e) None of these

Ans. (c)

Solutions: Let water is x
 $4x : x = \text{milk} : \text{water}$
 $32 : 8 = 4x : x$ (since total 40 liters)

Now $\frac{32}{8+x} = \frac{2}{3}, x = 40$ Liters

Q: 110: Rambo took a loan of Rs. 1200 with simple interest for as many years as the rate of interest. If he paid Rs. 432 as interest at the end of the loan period, what was the rate of interest?

- a) 3.6
- b) 6
- c) 18
- d) Data inadequate
- e) None of these

Solution:

Let rate = R% and time = R years

$$\text{Then, } [1200 \times R \times R / 100] = 432$$

$$12 r^2 = 432$$

$$R^2 = 36$$

$$R = 6$$

REASONING ABILITY

Directions: You have to consider the statement & the following assumptions & decide which of the assumptions is implicit in the statement.

- 1) If only assumption I is implicit.
- 2) If only assumption II is implicit.
- 3) If either assumption I or II is implicit.
- 4) If neither assumption I nor II is implicit.
- 5) If both the assumptions I & II are implicit.

Q: 111: Statement:-

The police in India have to cope with tremendous stress & strain while having to maintain security & order.

Assumptions:-

- I. In other countries, the police will not be having stress & strain while doing their duty.
- II. The police are anticipated to do their duties without stress or strain.

Explanation:-

Assumption I is not implicit because, the statement is based only on what happens in India.

Assumption II is implicit because of the concern shown in the statement.

Hence, only assumption II is implicit.

Q: 112: Statement:-

“Tenders are invited from reputed contractors for pre-qualification.”-The tender notice of a public sector company.

Assumptions:-

- I. The company seeks to do quality business.
- II. The company expects contractual & competitive rates for its work.

Explanation:-

Assumption I is implicit because, the word 'reputed contractors' suggests that, the company wants to do quality business.

Assumption II is implicit because, it is a universal assumption as the principal reason of inviting tenders.

Hence, option (5), both I & II is implicit.

Q: 113: Statement:-

The state government 'C' is committed to restrict smoke levels on the roads of the metropolis as per the desired parameters.

Assumptions:-

- I. It is possible to determine the smoke levels.
- II. A committed government can carry forward welfare measures for its people.

Explanation:-

The government has promised to bring down the smoke level because it is possible to determine the level. Hence, I is implicit. Assumption II is implicit because eliminating pollution is also a welfare measure.

Hence, Both Assumption I & II are implicit.

Q: 114: Statements:-

It has been felt that at a time when the airline faces tough competition & is passing through critical economic conditions, the remaining higher posts should be opened for outside professionals instead of filling them up with insider applicants.

Assumptions:-

- I. The internal applicants only aspire for promotion without contributing much to the organisation.
- II. It is most likely that problems of the airline would be solved by experienced professionals.

Explanation:-

The intention of internal applicants can't be assumed from the given statement. Assumption II is implicit, that is why they want to recruit outside professionals. Hence, Only Assumption II is implicit.

Q: 115: Statements:-

Highly brilliant & industrious students do not always excel in the written examination.

Assumptions:-

- I. The written examination is good mainly for mediocre students.
- II. The brilliant & industrious students cannot always write good answer in the exam.

Explanation:-

What we are being told about brilliant students does not have anything to do with mediocre students. Hence Assumption I is not implicit. But Assumption II is implicit. This must be the reason why the brilliant students do not always excel. Hence, Assumption II is implicit.

Q: 116. Statement : Should the tuition fees in all post graduate courses be hiked considerably ?

Arguments :

- I. Yes. This will bring some kind of seriousness among the students and will improve quality.
 - II. No. This will force the meritorious poor students to stay away from post-graduate courses.
- a. Only argument I is strong
 - b. Only argument II is strong
 - c. Either I or II is strong
 - d. Neither I nor II is strong
 - e. Both I and II are strong

Solution : B) Clearly seriousness among the students is not because of fees but second argument is strong.

Q: 117. Statement: Should students union in universities be abolished ?

Arguments :

- I. Yes. Students can pay full attention to their career development.
 - II. No. All the great leaders had been students union leaders.
- a. Only argument I is strong
 - b. Only argument II is strong

- c. Either I or II is strong
- d. Neither I nor II is strong
- e. Both I and II are strong

Solution: A)

Q: 118. Statement: Should persons convicted of criminal offences in the past be allowed to contest elections in India?

Arguments:

- I. No. Such persons cannot serve the cause of the people and country.
 - II. Yes. It is democracy - let people decide whom to vote.
- a. Only argument I is strong
 - b. Only argument II is strong
 - c. Either I or II is strong
 - d. Neither I nor II is strong
 - e. Both I and II are strong

Solution: A) Clearly, persons with criminal background cannot stand to serve as the representatives of the common people. So, they should not be allowed to contest elections. Thus, only argument I holds, while II does not.

Q: 119. Statement: Should cutting of trees be banned altogether?

Arguments:

- I. Yes. It is very much necessary to do so to restore ecological balance.
 - II. No. A total ban would harm timber based industries.
- a. Only argument I is strong
 - b. Only argument II is strong
 - c. Either I or II is strong
 - d. Neither I nor II is strong
 - e. Both I and II are strong

Solution: E)

Q: 120. Statement: Should the political parties be banned?

Arguments:

- I. Yes. It is necessary to teach a lesson to the politicians.
 - II. No. It will lead to an end of democracy.
- a. Only argument I is strong
 - b. Only argument II is strong
 - c. Either I or II is strong

- d. Neither I nor II is strong
e. Both I and II are strong

Solution: D) Clearly, with the ban on political parties, candidates can independently contest elections. So, it will not end democracy. Thus, argument II does not hold. Argument I does not give a strong reason.

Directions: Study the following information carefully and answer the questions given below:

There are eight children named Kunal, Leena, Gaurav, Fatima, Micky, Jony, Heena and Tinku are sitting around a circular table facing the centre. Each of them has their favourite subject – Maths, Chemistry, Physics, Science, Economics, Hindi, Urdu and English but not necessarily in the same order.

Fatima is sitting second to the left of Kunal. The child who likes Hindi is an immediate neighbour of Kunal. There are three children between the Tinku and the child who likes Hindi. Only one child sits between the child who likes maths and Tinku. The child who likes economics is to the immediate right of the child who likes maths. Micky is second to the right of Kunal. Heena likes Hindi. Gaurav and Jony are immediate neighbour of each other. Neither Gaurav nor Jony likes maths. The child who likes urdu is to the immediate left to Fatima. The child who likes physics is second to the right of the child who likes economics. The child who likes English is an immediate neighbour of the child who likes Maths. Gaurav is the second to the right of the child who likes Chemistry.

Q: 121. Who is the forth to the right of Kunal?

- A. Fatima
B. Leena
C. Micky
D. Jony
E. Gaurav

Solution: D)

S.No.	Child Name	Favourite Subject
1	Kunal	English
2	Leena	Maths
3	Micky	Economics
4	Tinku	Chemistry
5	Jony	Physics

RBI Grade B 2018 Phase 1

6	Gaurav	Urdu
7	Fatima	Science
8	Heena	Hindi

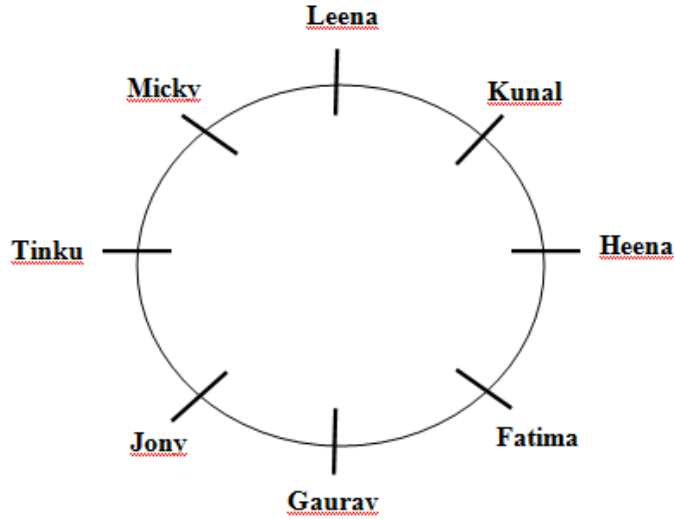

Q: 122. Which subject does like Fatima?

- A. Maths
- B. Hindi
- C. Science
- D. Urdu
- E. Physics

Solution: C)

S.No.	Child Name	Favourite Subject
1	Kunal	English
2	Leena	Maths
3	Micky	Economics
4	Tinku	Chemistry
5	Jony	Physics
6	Gaurav	Urdu
7	Fatima	Science
8	Heena	Hindi

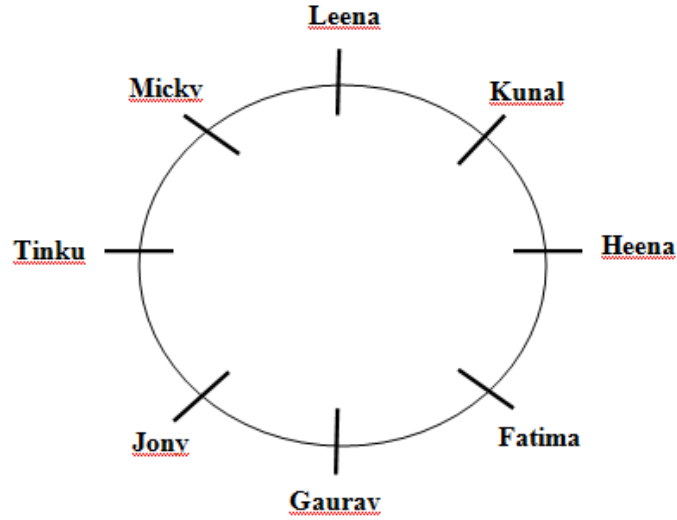

Q: 123. Which one is correct?

- A. Tinku - Physics
- B. Heena - Science
- C. Micky - Economics
- D. Jony - Maths
- E. None of these

Solution: C)

S.No.	Child Name	Favourite Subject
1	Kunal	English
2	Leena	Maths
3	Micky	Economics
4	Tinku	Chemistry
5	Jony	Physics
6	Gaurav	Urdu
7	Fatima	Science
8	Heena	Hindi

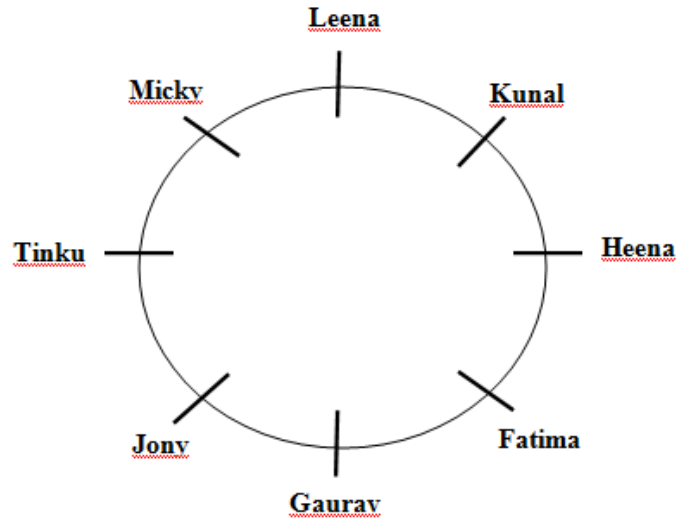

Q: 124. Which of the following represents the immediate neighbour of Leena?

- A. Tinku
- B. Kunal
- C. Jony
- D. Fatima
- E. Heena

Solution: B)

S.No.	Child Name	Favourite Subject
1	Kunal	English
2	Leena	Maths
3	Micky	Economics
4	Tinku	Chemistry
5	Jony	Physics
6	Gaurav	Urdu
7	Fatima	Science
8	Heena	Hindi

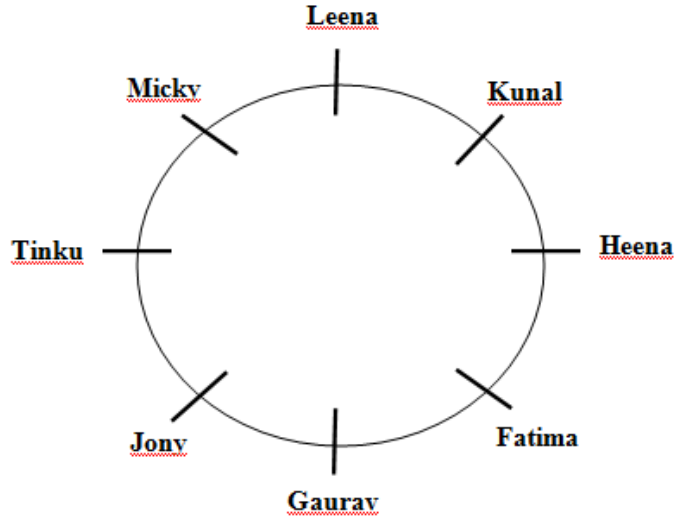

Q: 125. Who likes maths?

- A. Kunal
- B. Leena
- C. Gaurav
- D. Can not be determined
- E. None of these

Solution: B)

S.No.	Child Name	Favourite Subject
1	Kunal	English
2	Leena	Maths
3	Micky	Economics
4	Tinku	Chemistry
5	Jony	Physics
6	Gaurav	Urdu
7	Fatima	Science
8	Heena	Hindi

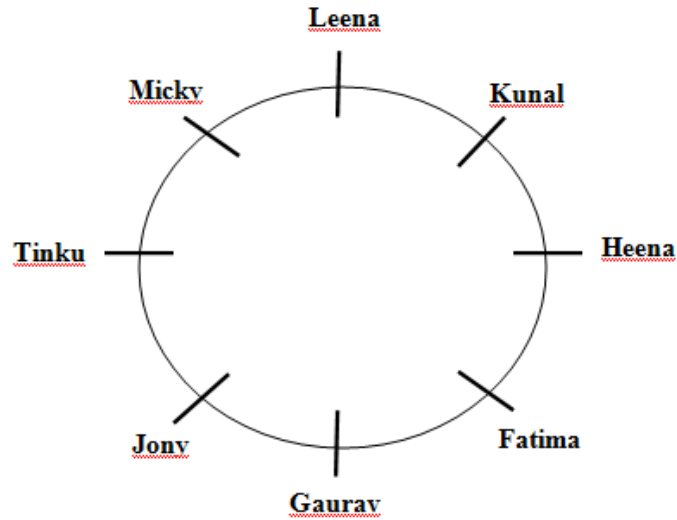

Q: 126. Who is the second to the right of the child who likes English?

- A. Micky
- B. Jony
- C. Fatima
- D. Kunal
- E. Tinku

Solution: A)

S.No.	Child Name	Favourite Subject
1	Kunal	English
2	Leena	Maths
3	Micky	Economics
4	Tinku	Chemistry
5	Jony	Physics
6	Gaurav	Urdu
7	Fatima	Science
8	Heena	Hindi

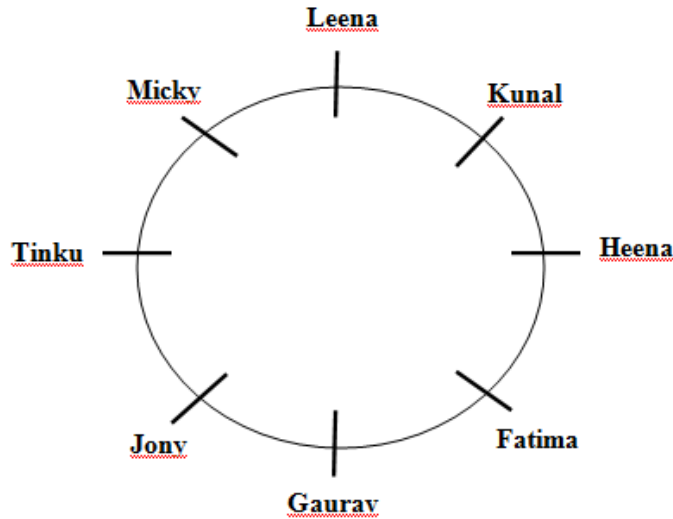

Direction: Each of the questions below consists of a question and two statements numbered 1 and 2 are given below it. You have to decide whether the data provided in the statements are sufficient to answer the question or not.

Q: 127: Who is the daughter of B?

1. F is the brother of A. A is the husband of B.
2. A has two children C and E. C is the sister of E.

- A. The data in Statement 1 alone are sufficient to answer the question, while the data in Statement 2 alone are not sufficient to answer the question.
- B. The data in Statement 2 alone are sufficient to answer the question, while the data in Statement 1 alone are not sufficient to answer the question.
- C. The data in Statement 1 alone or in Statement 2 alone are sufficient to answer the question.
- D. The data in both the Statements 1 and 2 are not sufficient to answer the question.
- E. The data in both the Statements 1 and 2 together are necessary to answer the question.

Ans. E.

Solution:

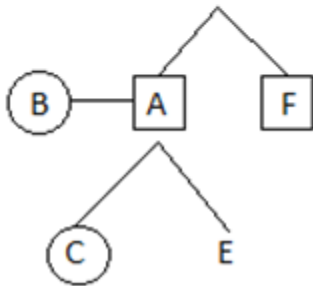
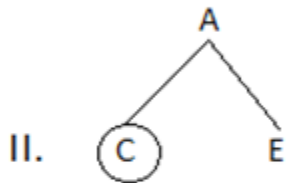
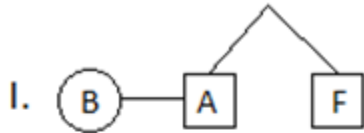

Q: 128: There are five persons M, N, O, P and Q in a family. Each of them has a different height. Who is tallest?

1. Q is smaller than only P and N. P is not tallest.
2. P is taller than three. N is taller than Q.

- A. The data in Statement 1 alone are sufficient to answer the question, while the data in Statement 2 alone are not sufficient to answer the question.
- B. The data in Statement 2 alone are sufficient to answer the question, while the data in Statement 1 alone are not sufficient to answer the question.
- C. The data in Statement 1 alone or in Statement 2 alone are sufficient to answer the question.
- D. The data in both the Statements 1 and 2 are not sufficient to answer the question.
- E. The data in both the Statements 1 and 2 together are necessary to answer the question.

Ans. A.

Solution:

From I = $M/O < M/O < Q < P < N$

Q: 129: Six persons A, B, C, D, E and F are sitting around a circular table facing towards the centre. Who is the immediate left of F?

1. A is sitting between D and B.
 2. B is sitting between A and E. F is sitting immediate left of C.
- A. The data in Statement 1 alone are sufficient to answer the question, while the data in Statement 2 alone are not sufficient to answer the question.
- B. The data in Statement 2 alone are sufficient to answer the question, while the data in Statement 1 alone are not sufficient to answer the question.
- C. The data in Statement 1 alone or in Statement 2 alone are sufficient to answer the question.
- D. The data in both the Statements 1 and 2 are not sufficient to answer the question.
- E. The data in both the Statements 1 and 2 together are necessary to answer the question.

Ans. D.

Solution:

From I + II = D or E sits immediate left of F.

Because we don't get the exact person who is immediate left of F. So I and II are insufficient to give the answer.

Q: 130: in which of the following date did Shweta not go to office?

1. If Ajay remembered that she did not go to office after 20 but before 25.
 2. If Rahul remembered that she took a leave after 23 but before 28.
- A. The data in Statement 1 alone are sufficient to answer the question, while the data in Statement 2 alone are not sufficient to answer the question.
- B. The data in Statement 2 alone are sufficient to answer the question, while the data in Statement 1 alone are not sufficient to answer the question.
- C. The data in Statement 1 alone or in Statement 2 alone are sufficient to answer the question.
- D. The data in both the Statements 1 and 2 are not sufficient to answer the question.
- E. The data in both the Statements 1 and 2 together are necessary to answer the question.

Ans. E.

Solution:

I. 21, 22, 23, 24

II. 24, 25, 26, 27

From I + II = 24

Directions: A, B, C, D, E, F, G, H and I are nine people living on nine different floors of a building but not necessarily in the same order. The lowermost floor of the building is numbered 1, the one above that is numbered 2 and so on till the topmost

floor is numbered 9. Each of them plays a different game like- Chess, Football, Kho-Kho, Cricket, Hockey, Carrom, Table-tennis, Badminton, Tennis.

- There are 3 floors between I and the one who plays cricket.
- I lives on an even number floor.
- The one who plays Kho-Kho lives immediately below the one who plays cricket.
- 2 person live between I and G. G does not like Kho-Kho. H lives immediately above C.
- One person lives between H and A.
- The one who plays table tennis lives immediately below G. C likes Kho-Kho.
- Two persons live between the one who likes hockey and the one who likes badminton.
- B plays hockey. B does not live immediately above H.
- The one who plays chess lives immediately above E.
- G does not play chess.
- D plays football. E plays tennis.

Q: 131. Which of the following does play Carrom?

- A. B
- B. G
- C. I
- D. A
- E. None of these

Solution: B)

9.	G	Carrom
8.	F	Table tennis
7.	B	Hockey
6.	I	Chess
5.	E	Tennis
4.	A	Batminton
3.	D	Football
2.	H	Cricket
1.	C	Kho-Kho

Q: 132. Who among the following lives immediately above B?

- A. The one who plays tennis
- B. A
- C. The one who plays table tennis
- D. E
- E. D

Solution: C)

9.	G	Carrom
8.	F	Table tennis
7.	B	Hockey
6.	I	Chess
5.	E	Tennis
4.	A	Badminton
3.	D	Football
2.	H	Cricket
1.	C	Kho-Kho

Q: 133. Four of the following five are alike in a certain way and hence form a group. Which of them does not belong to the group?

- A. Carrom-B
- B. Chess-A
- C. Badminton-D
- D. Tennis-D
- E. Hockey-E

Solution: C)

9.	G	Carrom
8.	F	Table tennis
7.	B	Hockey
6.	I	Chess
5.	E	Tennis
4.	A	Batminton
3.	D	Football
2.	H	Cricket
1.	C	Kho-Kho

Q: 134. Which of the following is not true?

- A. F-Table tennis
- B. H-Cricket
- C. I-Chess
- D. C-Hockey
- E. D-Football

Solution: D)

9.	G	Carrom
8.	F	Table tennis
7.	B	Hockey
6.	I	Chess
5.	E	Tennis
4.	A	Batminton
3.	D	Football
2.	H	Cricket
1.	C	Kho-Kho

Q: 135. C plays which of the following games?

- A. Tennis
- B. Badminton
- C. Kho Kho
- D. Hockey
- E. Cricket

Solution: C)

9.	G	Carrom
8.	F	Table tennis
7.	B	Hockey
6.	I	Chess
5.	E	Tennis
4.	A	Batminton
3.	D	Football
2.	H	Cricket
1.	C	Kho-Kho

Direction: There are eight persons Akanksha, Aarohi, Aayushi, Arun, Aarav, Ananya, Akash and Aarush are sitting around a circular table in which four are facing outside and others are facing inside but not necessarily in the same order. Each of them has different amount of money i.e. 77, 81, 92, 97, 108, 113, 119 and 126 but not necessarily in the same order.

- Aarush has RS. 97 and sits third to the right of Ananya.
- Aakash has that amount of money which is a prime number.
- There is only one person between akanksha and Arun who has more than 110 RS.
- Aakash sits second to the right of Aayushi and fourth to the left of Aarav.
- Aayushi is not an immediate neighbor of Akanksha.
- Immediate neighbors of Aayush face in the same direction while immediate neighbors of Akanksha face in the opposite direction.
- The difference in the money of Aarav and Aakash is 11.
- The one who has RS.77 sits second to the right of Akanksha.
- Aayushi sits third to the left of Arun and both are facing in opposite direction.
- The one who has RS.126 is an immediate neighbor of Akanksha and faces inside.
- Akanksha has that amount of money which is divisible by 9 but not by 18.

Q: 136. Who among the following person has RS.38 Less than Akash?

- Ayushi
- Ananya
- Akanksha
- Aarush
- None of these

Solution: C)

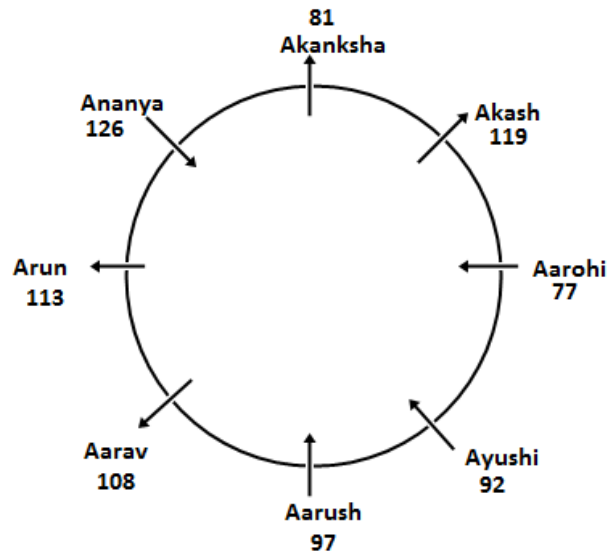

Q: 137. Who among the following person sits second to the right of Aarav?

- a. The one who has RS.81
- b. The one who has RS. 126
- c. Ayushi
- d. Aarohi
- e. None of these

Solution: B)

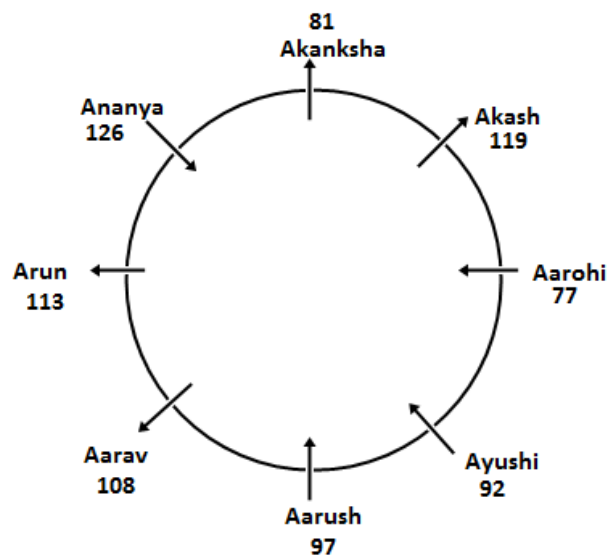

Q: 138. Four of the following five are alike in a certain way that they form a group. Which of the following doesn't belong to that group?

- a. Aakash
- b. Aarav
- c. Arun
- d. Akanksha
- e. Ayushi

Solution: E)

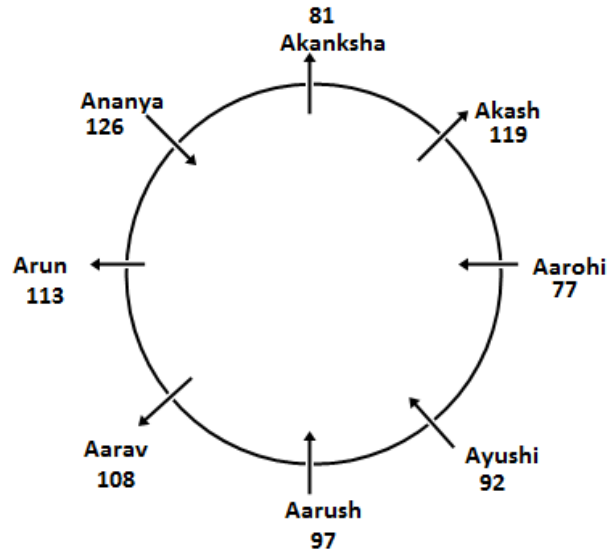

Q: 139. Who among the following person sits between the one who has RS.77 and the one who has RS.97?

- a. Ayushi
- b. Aarav
- c. The one who has RS. 126
- d. (c) & (d)
- e. None of these

Solution: A)

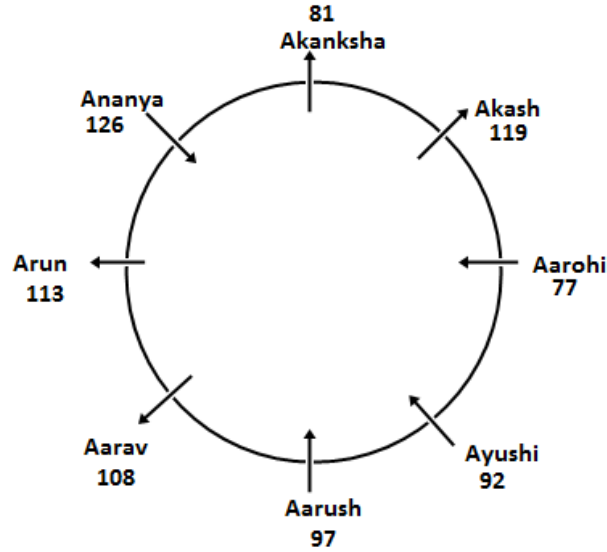

Q: 140. Who among the following person faces outside of the table?

- a. Aarush
- b. The one who has RS.92
- c. The one who has RS.113
- d. Ananya
- e. Aarohi

Solution: C)

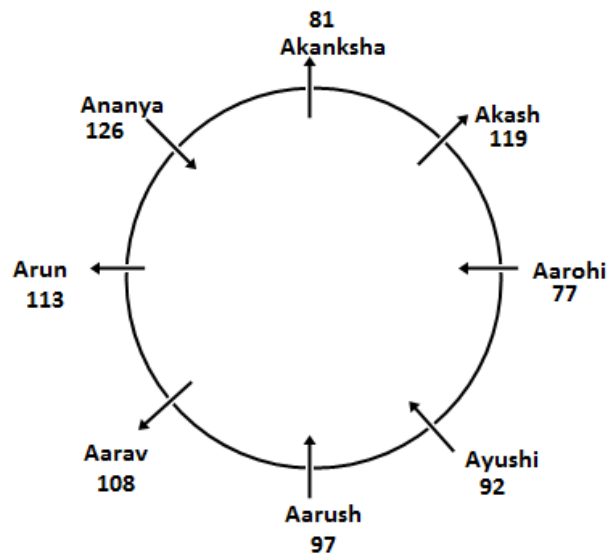

Directions: Seven friends- Riya, Reena, Ritu, Rekha, Radhika, Radha, Reema are going to seven cities like Delhi, Mumbai, Bangalore, Agra, Nainital, Hyderabad and Indore on different seven days of weeks starting from Monday to Sunday. Each of them likes seven

different colours viz. Red, Blue, Purple, Green, Orange, Yellow and Violate. But not necessary in the same order.

Reema is going to Nainital on Wednesday but likes neither Blue nor Green. The one who likes Green colour is going to Banglour. Rekha is going on Monday. Riya likes Red colour. The one who is going to Agra on Tuesday does not like Red colour. Reena likes Blue colour. Radha is going to Indore on Sunday. Radhika neither is going to Agra nor likes Green colour. Ritu likes either Orange or Violate colour. The one who likes Violet colour is going to Hyderabad. Radha does not like Purple colour. Riya is going to Delhi on Thursday. Radhika is not going on Saturday.

Q: 141: In which of the following day is Radhika going on?

- A. Tuesday
- B. Friday
- C. Thursday
- D. Wednesday
- E. None of these

Ans. B.

Solution:



Name	City	Days	Colour
Riya	Delhi	Thursday	Red
Ritu	Agra	Tuesday	Orange
Reena	Mumbai	Saturday	Blue
Reema	Nainital	Wednesday	Purple
Rekha	Banglour	Monday	Green
Radhika	Hydrabad	Friday	Violet
Radha	Indore	Sunday	Yellow

Q: 142: The one who likes Purple is going which of the city?

- A. Nainital
- B. Agra
- C. Delhi
- D. Indore
- E. None of these

Ans. A.

Solution:

Name	City	Days	Colour
Riya	Delhi	Thursday	Red
Ritu	Agra	Tuesday	Orange
Reena	Mumbai	Saturday	Blue
Reema	Nainital	Wednesday	Purple
Rekha	Banglour	Monday	Green
Radhika	Hydrabad	Friday	Violet
Radha	Indore	Sunday	Yellow

Q: 143: Which of the following is definitely true?

- A. Riya-Delhi-Red-Tuesday
- B. Reena-Saturday-Mumbai-Orange
- C. Rekha-Banglour-Monday-Green
- D. Radha-Indore-Hydrabad-Saturday
- E. None of these

Ans. C.

Solution:

Name	City	Days	Colour
Riya	Delhi	Thursday	Red
Ritu	Agra	Tuesday	Orange
Reena	Mumbai	Saturday	Blue
Reema	Nainital	Wednesday	Purple
Rekha	Banglour	Monday	Green
Radhika	Hydrabad	Friday	Violet
Radha	Indore	Sunday	Yellow

Q: 144: Who likes Orange colour?

- A. Riya
- B. Reema
- C. Radha
- D. Ritu
- E. None of these

Ans. D.

Solution:

Name	City	Days	Colour
Riya	Delhi	Thursday	Red
Ritu	Agra	Tuesday	Orange
Reena	Mumbai	Saturday	Blue
Reema	Nainital	Wednesday	Purple
Rekha	Banglour	Monday	Green
Radhika	Hydrabad	Friday	Violet
Radha	Indore	Sunday	Yellow

Q: 145: Which of the following is going to Mumbai?

- A. Ritu
- B. Reena
- C. Rekha
- D. Reema
- E. None of these

Ans. B.

Solution:



Name	City	Days	Colour
Riya	Delhi	Thursday	Red
Ritu	Agra	Tuesday	Orange
Reena	Mumbai	Saturday	Blue
Reema	Nainital	Wednesday	Purple
Rekha	Banglour	Monday	Green
Radhika	Hydrabad	Friday	Violet
Radha	Indore	Sunday	Yellow

Directions : In each group of questions below are two conclusions followed by five statements. You have to choose the correct set of statements that logically satisfies given conclusions.

Q: 146: Conclusions:

- I. Some silver are not ring.
- II. Some platinum are not chain.

Statements:

- I. All rings are gold. Some gold is chain. Some chain is silver. No silver is platinum.
- II. Some rings are gold. All gold is chain. Some chain is silver. No silver is platinum.
- III. All rings are gold. All gold is chain. Some chain is silver. Some silver is platinum.
- IV. Some rings are gold. Some gold is chain. No chain is silver. Some silver is platinum. No platinum is ring.
- V. Some rings are gold. Some gold is chain. Some chain is silver. Some silver is platinum.

- A. Only statement II.
- B. Only statement III.
- C. Only statement I.
- D. Only statement IV.
- E. Only statement V.

Ans. D.

Solution:

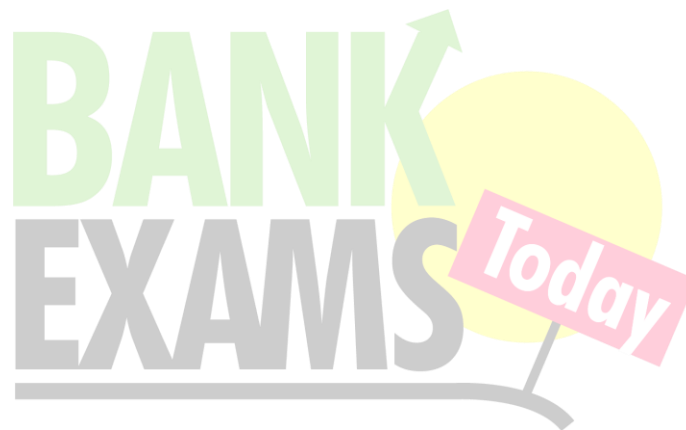

Q: 147: Conclusions:

- I. All fridges being AC is a possibility.
- II. No iron is hot.

Statements:

- I. Some fridges are cooler. No cooler is iron. All iron is AC. Some AC is hot.
- II. All fridges are cooler. Some cooler are iron. No iron is AC. Some AC is hot.
- III. All fridges are cooler. No cooler is AC. All iron is AC. Some AC is hot.
- IV. All fridges are cooler. All cooler are AC. Some AC is iron. Some iron is hot.
- V. Some fridges are cooler. Some cooler are iron. All iron is AC. No AC is hot.

- A. Only statement II.

- B. Only statement III.
- C. Only statement I.
- D. Only statement IV.
- E. Only statement V.

Ans. E.

Solution:

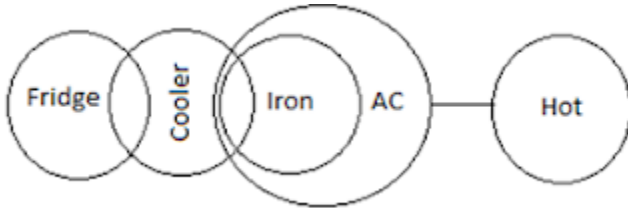

Q: 148: Conclusions:

- I. Some pencil is not pen.
- II. All gift being eraser is a possibility.

Statements:

- I. All gifts are box. Some gifts are pen. No pen is eraser. Some erasers are pencil.
- II. All gifts are box. All boxes are pen. No pen is eraser. Some erasers are pencil.
- III. Some gifts are box. All pens are box. No pen is eraser. Some erasers are pencil.
- IV. No gift is box. Some boxes are pen. All pens are eraser. Some erasers are pencil.
- V. All gifts are box. No box is pen. Some pens are eraser. All erasers are pencil.

- A. Only statement II.
- B. Only statement III.
- C. Only statement I.
- D. Only statement IV.
- E. Only statement V.

Ans. B.

Solution:

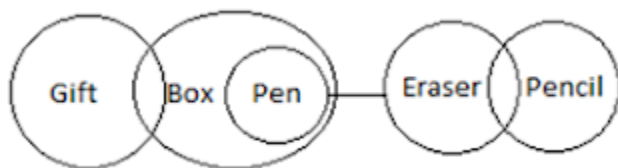

Q: 149: Conclusions:

- I. Some watches are second.
- II. All time being second is a possibility.

Statements:

- I. All time are hour. Some hours are watch. Some watches are minute. All minutes are

second.

II. All time are hour. Some hours are watch. No watch is minute. All minutes are second.

III. Some time is hour. Some hours are watch. No watch is minute. Some minutes are second.

IV. All time are hour. No hour is watch. Some watches are minute. Some minutes are second.

V. All time are hour. Some hours are watch. Some watches are minute. Some minutes are second.

A. Only statement II.

B. Only statement III.

C. Only statement I.

D. Only statement IV.

E. Only statement V.

Ans. C.

Solution:

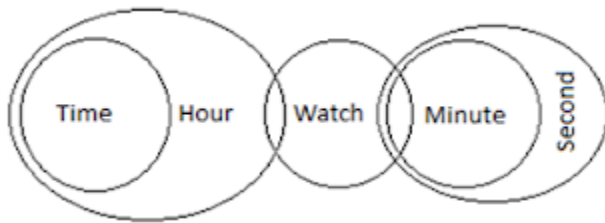

Q: 150: Conclusions:

I. Some chairs are fan.

II. All books being bed is a possibility.

Statements:

I. Some bottles are fan. No fan is chair. Some chairs are bed. All beds are book.

II. All bottles are fan. Some fans are chair. Some chairs are bed. All beds are book.

III. Some bottles are fan. All fans are chair. Some chairs are bed. No bed is book.

IV. All bottles are fan. No fan is chair. Some chairs are bed. Some beds are book.

V. All bottles are fan. All fans are chair. Some chairs are bed. No bed is book.

A. Only statement II.

B. Only statement III.

C. Only statement I.

D. Only statement IV.

E. Only statement V.

Ans. A.

Solution:

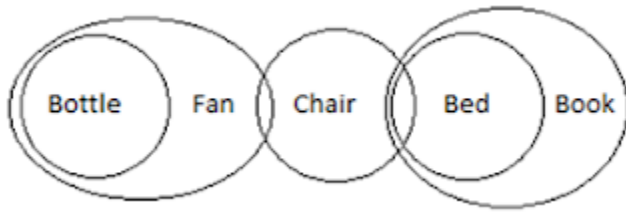

Directions: A word and number arrangement machine, when given an input line of words and numbers, rearranges them following a unique rule in each step. Following is an illustration of input and rearrangement.

Input: Punjab Haryana 82 Kashmir 35 14 Assam 66 50 Mizoram

Step I: 66 Punjab 82 Kashmir 35 14 Assam 50 Mizoram Haryana

Step II: 35 66 Punjab 82 Kashmir 14 50 Mizoram Haryana Assam

Step III: 14 35 66 Punjab 82 Kashmir 50 Haryana Assam Mizoram

Step IV: 50 14 35 66 82 Kashmir Haryana Assam Mizoram Punjab

Step V: 82 50 14 35 66 Haryana Assam Mizoram Punjab Kashmir

Step V is the last step of the arrangement. As per the rules followed in the above steps, Find out the appropriate answer for the each question for the given input.

Input: White Black 42 Brown 85 Merun 99 Green 84 39

Q: 151: If in step III Black and Brown gets interchanged and if 99 and 39 get interchanged, then which element will be 4th from the right end?

- A. Brown
- B. 99
- C. 39
- D. Black
- E. None of these

Solution: B)

Input: White Black 42 Brown 85 Merun 99 Green 84 39

Step I: 99 White Black 42 Brown 85 Green 84 39 Merun

Step II: 42 99 White Black 85 Green 84 39 Merun Brown

Step III: 85 42 99 Black Green 84 39 Merun Brown White

Step IV: 84 85 42 99 Black 39 Merun Brown White Green

Step V: 39 84 85 42 99 Merun Brown White Green Black

Number arrangement:

Arranged in ascending order of difference between the digits.

$$9 - 9 = 0$$

$$4 - 2 = 2$$

$$8 - 5 = 3$$

$$8 - 4 = 4$$

$$9 - 3 = 6$$

Words arrangement:

Alphabetic descending order of middle letter of the word.

MeRun

BrOwn

WhIte

GrEen

BlAck

Q: 152: Which element is third to the left of the one which is 8th from the left end in the last but one step of the given Input?

A. 99

B. Black

C. 39

D. No such element

E. None of these

Solution: B)

Input: White Black 42 Brown 85 Merun 99 Green 84 39

Step I: 99 White Black 42 Brown 85 Green 84 39 Merun

Step II: 42 99 White Black 85 Green 84 39 Merun Brown

Step III: 85 42 99 Black Green 84 39 Merun Brown White

Step IV: 84 85 42 99 Black 39 Merun Brown White Green

Step V: 39 84 85 42 99 Merun Brown White Green Black

Number arrangement:

Arranged in ascending order of difference between the digits.

$$9 - 9 = 0$$

$$4 - 2 = 2$$

$$8 - 5 = 3$$

$$8 - 4 = 4$$

$$9 - 3 = 6$$

Words arrangement:

Alphabetic descending order of middle letter of the word.

MeRun

BrOwn

WhIte

GrEen

BLAck

Q: 153: Which element comes exactly between 85 and Brown in the last step?

A. White

B. 42

C. Merun

D. 99

E. None of these

Solution: D)

Input: White Black 42 Brown 85 Merun 99 Green 84 39

Step I: 99 White Black 42 Brown 85 Green 84 39 Merun

Step II: 42 99 White Black 85 Green 84 39 Merun Brown

Step III: 85 42 99 Black Green 84 39 Merun Brown White

Step IV: 84 85 42 99 Black 39 Merun Brown White Green

Step V: 39 84 85 42 99 Merun Brown White Green Black

Number arrangement:

Arranged in ascending order of difference between the digits.

$$9 - 9 = 0$$

$$4 - 2 = 2$$

$$8 - 5 = 3$$

$$8 - 4 = 4$$

$$9 - 3 = 6$$

Words arrangement:

Alphabetic descending order of middle letter of the word.

MeRun

BrOwn

WhIte
GrEen
BlAck

Q: 154: In which step ' Black Green 84 39 and Merun ' comes in the same order?

- A. Step II
- B. Step III
- C. Step IV
- D. No such step
- E. None of these

Solution: B)

Input: White Black 42 Brown 85 Merun 99 Green 84 39

Step I: 99 White Black 42 Brown 85 Green 84 39 Merun

Step II: 42 99 White Black 85 Green 84 39 Merun Brown

Step III: 85 42 99 Black Green 84 39 Merun Brown White

Step IV: 84 85 42 99 Black 39 Merun Brown White Green

Step V: 39 84 85 42 99 Merun Brown White Green Black

Number arrangement:

Arranged in ascending order of difference between the digits.

$$9 - 9 = 0$$

$$4 - 2 = 2$$

$$8 - 5 = 3$$

$$8 - 4 = 4$$

$$9 - 3 = 6$$

Words arrangement:

Alphabetic descending order of middle letter of the word.

MeRUn

BrOwn

WhIte

GrEen

BlAck

Q: 155: In how many steps does Green comes before Merun?

- A. One
- B. Two
- C. Three

- D. Four
- E. None of these

Solution: C)

Input: White Black 42 Brown 85 Merun 99 Green 84 39

Step I: 99 White Black 42 Brown 85 Green 84 39 Merun

Step II: 42 99 White Black 85 Green 84 39 Merun Brown

Step III: 85 42 99 Black Green 84 39 Merun Brown White

Step IV: 84 85 42 99 Black 39 Merun Brown White Green

Step V: 39 84 85 42 99 Merun Brown White Green Black

Number arrangement:

Arranged in ascending order of difference between the digits.

$$9 - 9 = 0$$

$$4 - 2 = 2$$

$$8 - 5 = 3$$

$$8 - 4 = 4$$

$$9 - 3 = 6$$

Words arrangement:

Alphabetic descending order of middle letter of the word.

MeRun

BrOwn

WhIte

GrEen

BlAck

Directions: There are some people in a family. Jyoti is the grandmother of Ananya. Hemant is the husband of Aanchal who is sister in law of Aarushi. Arun is the maternal uncle of Ritu and Manoj. Meena is the father of Seema. Arun is the uncle of Nitu. Nitu is the granddaughter of Jyoti. Arun is the brother of Seema who is the husband of Aarushi. Ananya and Nitu is the Daughter of Aarushi. Ritu & Manoj is the son of Hemant.

Q: 156: How is Aarushi related to Meena?

- A. Sister in law
- B. Daughter in law
- C. Daughter

- D. Son
- E. Wife

Solution: B)

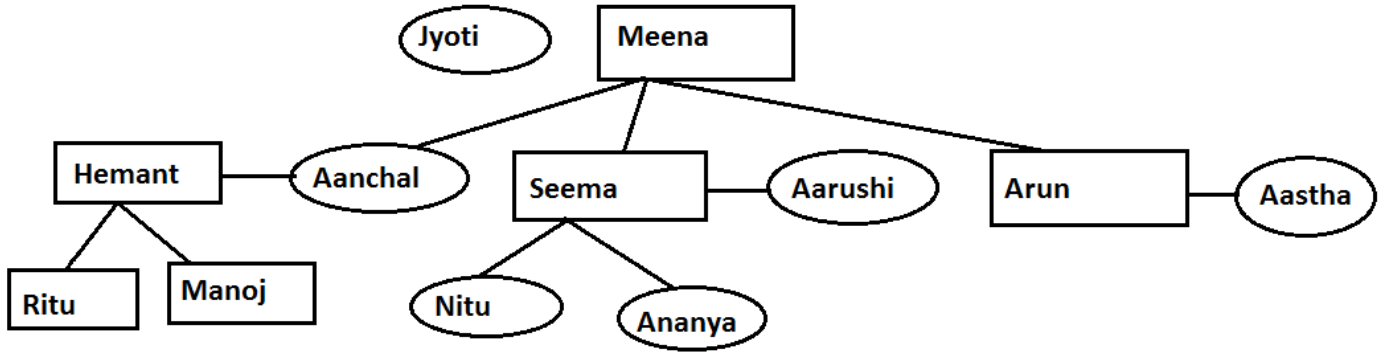

Q: 157: If Aastha is the wife of Arun then how is Jyoti related to Aastha?

- A. Daughter in law
- B. Husband
- C. Son
- D. Mother in law
- E. Father in law

Solution: D)

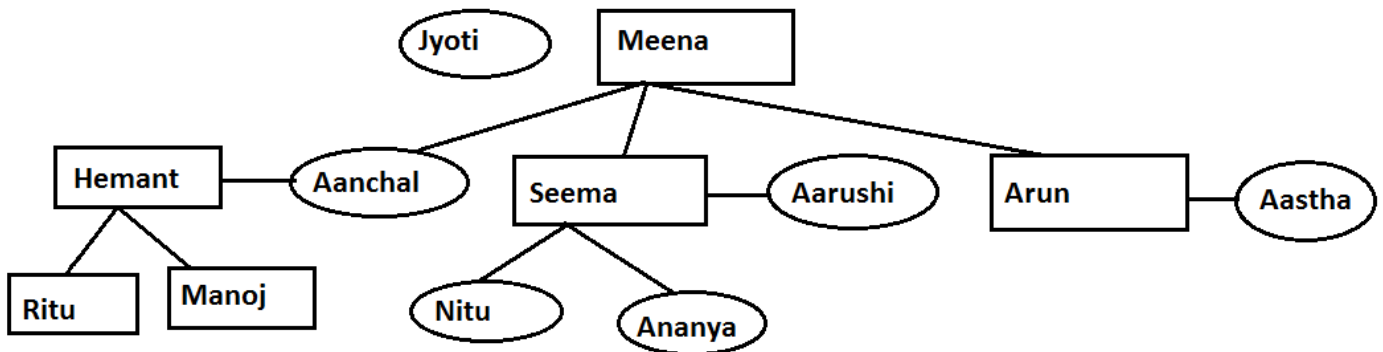

Q: 158: Who is the father of Nitu?

- A. Aarushi
- B. Hemant
- C. Seema
- D. Meena
- E. Arun

Solution: C)

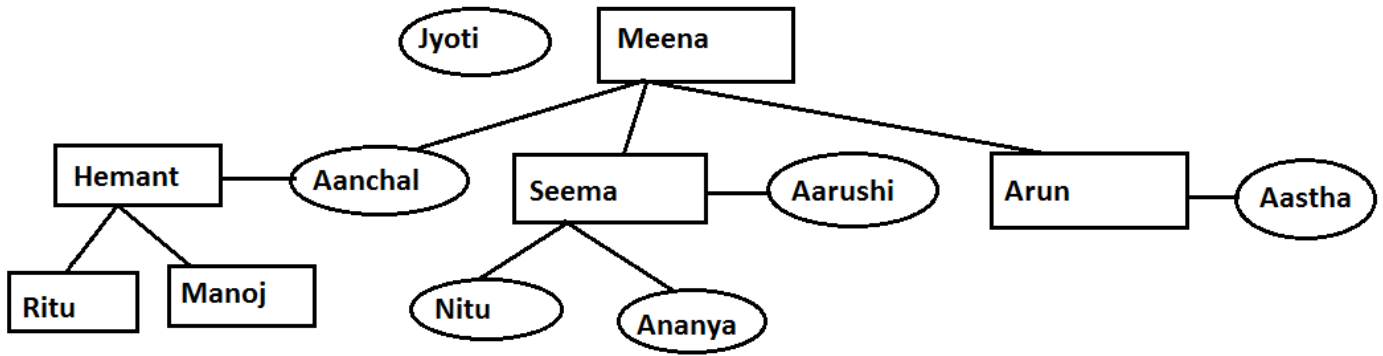

Directions: \$ means A is sister of B

@ means A is father of B

% means A is son of B

* means A is mother of B

means A is husband of B

P\$Q%S#T*R#V*W

Q: 159: How is W related to Q?

- A. Son
- B. Wife
- C. Uncle
- D. Aunt
- E. C. & D.

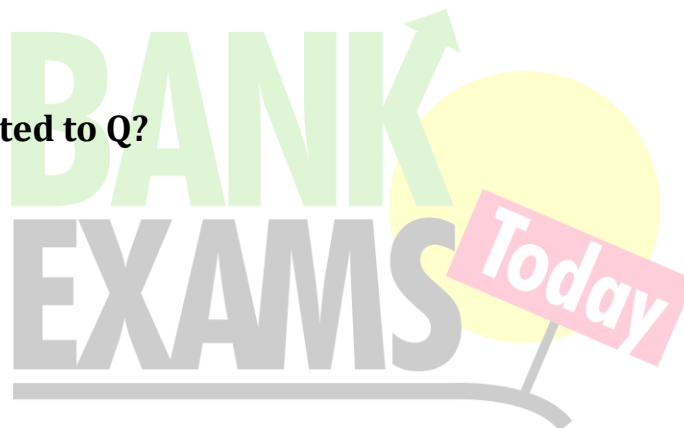

Solution: E)

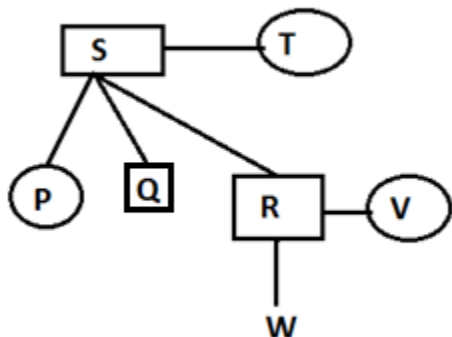

Q%B#P\$S#T@R

Q: 160: How is P related to R?

- A. Aunt
- B. Nephew

- C. Son
- D. Husband
- E. Father

Solution: A)

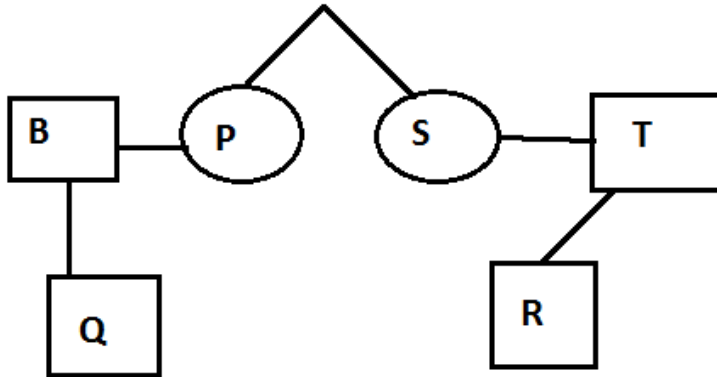

Directions: Read the directions carefully and answer the question:

- P#Q means P is 3 km. south of Q
- P\$Q means P is 4 km. west of Q
- P%Q means P is 2 km. north of Q
- P&Q means P is 5 km. east of Q

**Q: 161: According to given expression what is the direction of A with respect to E?
A&B%C&D#E**

- A. North - West
- B. South - East
- C. East
- D. South - West
- E. South

Solution: B)

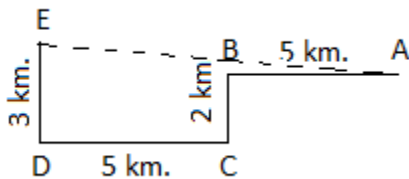

Q: 162: If the direction of M with respect to P is North - East then what should come at the place of question mark in the given expression?

M\$N%O?P

- A. \$
- B. %
- C. #
- D. &
- E. None of these

Solution: D)

M\$N%O&P

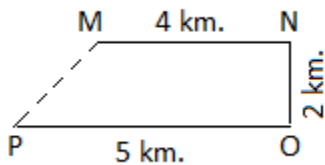

Q: 163: According to given expression what is the shortage distance between G and K?

G\$H%i&j#k

- A. $\sqrt{1}$
- B. $2\sqrt{2}$
- C. $\sqrt{3}$
- D. $\sqrt{2}$
- E. None of these

Solution: D)

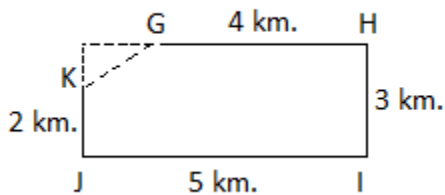

Shortest distance = $\sqrt{(12+12)} = \sqrt{2}$

Q: 164: Which of the following expressions means 'Z' is in the North - East of 'W'?

- A. W%X\$Y%Z
- B. W#X\$Y%Z
- C. W#X&Y%Z

- D. A and B
E. None of these

Solution: B)

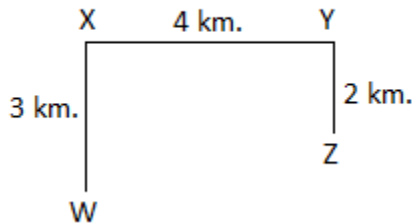

Directions: In a certain code language

"MONITOR, COMPUTER, KEYBOARD " is written as "\$&\$, \$#%, %\$@"

"COOLER, JACKET, CURTAIN" is written as "\$\$%, @%, #@&"

"MATERIAL, INTELLIGENT, SERIOUS" is written as "@%&@, &%&%, %&\$#"

"HOCKEY, BALANCE, INCREASE" is written as "\$%, @@%, &%@%"

Q: 165. The code for the word AGREEMENT is?

- A. %&##
B. @###
C. @%%%
D. #&%%
E. None of these

Solution: C)

The code for vowels:

A-@, E-%, I-&, O-\$, U-#

AGREEMENT (AEEE)= @%%%

Q: 166. What will be the code for INDUSTRY?

- A. #%&
B. &#
C. #&\$
D. @%&
E. None of these

Solution: B)

The code for vowels:

A-@, E-%, I-&, O-\$, U-#

INDUSTRY (IU)= &#

Q: 167. The code '&%%%' denotes which of the following word?

- A. HOCKEY
- B. REPUBLIC
- C. INCREASE
- D. INDEPENDENT
- E. None of these

Solution: D)

The code for vowels:

A-@, E-%, I-&, O-\$, U-#

INDEPENDENT (IEEE)= &%%%

Q: 168: 10 Girls and 9 boys are standing in a line. No two boys and no two girls are standing together. Neha is standing 4th to the left of Megha. If all the boys are removed then Neha is 7th from the right end. Find the position of Megha from the left end among 19 students.

- A. 10th
- B. 9th
- C. 11th
- D. 12th
- E. None of these

Ans. C.

Solution:

No two boys and no two girls are standing together means the sequence will be girl, boy, girl, boy...

If all the boys are removed then Neha is 7th from the right end. Among all the 19s Neha is 13th (7 girls +6 boys) from the right end.

Neha is standing 4th to the left of Megha it means Megha is standing 4th to the right of Neha.

So Megha is 9th (13-4) from the right end.

The position Megha from the right end = (total student - position from right end + 1)
=19-9+1

=11th

Q: 169: There are some students in a class. Mahesh is 19th from the left end and Mohan is 16th from the right end. If 12 students are sitting between them then find out the total students.

- A. 35
- B. 47
- C. 21
- D. Data Adequate
- E. None of these

Ans. D.

Solution:

The information is given is not sufficient to give the answer.

Direction: There are 7 children A, B, C, D, E, F and G who secured different marks in a class test.

A is secured more than D but less than G.

F is secured more than only B and C.

E secured the highest marks.

The one who is secured the second lowest marks secured 44 and the one who is secured the second highest marks secured 72 marks.

Q: 170. If B secures 8 marks more than C then how many marks did C secure?

- A. 40
- B. 36
- C. 38
- D. 42
- E. None of these.

Ans. B.

Solution:

According to the Direction: $E > G > A > D > F > B, C$

According to the Question: $E > G > A > D > F > B > C$

$$B = 44$$

$$B = C + 8$$

$$44 = C + 8$$

$$C = 36$$

ENGLISH

Directions: Read the following passage carefully and answer the questions given below it. Certain words have been printed in bold to help you located them while answering some of the questions.

Financial Inclusion (FI) is an emerging priority for banks that have nowhere else to go to achieve business growth. The viability of FI business is under question, because while banks and their delivery partners continue to make investments, they haven't seen commensurate returns. In markets like India, most programs are focused on customer on boarding, an expensive process which people often find difficult to afford, involving issuance of smart cards to the customers. However, large scale customer acquisition hasn't translated into large scale business. With many accounts lying **dormant** and therefore yielding no return on the bank's investment. For the same reason, Business Correspondent Agents who constitute the primary channel for financial inclusion are unable to pursue their activity as a full time job. One major reason for this slate of events is that the customer on boarding process is often **delayed** after the submission of documents (required to validate the details of the concerned applicant) by the applicant and fright take as long as two weeks. By this time the initial enthusiasm of applicants fades away. Moreover, the delivery partners don't have the knowledge and skill to Propose anything other than the most basic financial products to the customer and hence do not serve their banks' goal of expanding the offering in unbanked markets.

Contrary to popular perception, the inclusion segment is not a singular impoverished, undifferentiated mass and it is important to navigate its diversity to identify the right target customers for various programs. Rural markets do have their share of rich people who do not use banking services simply because they are inconvenient to access or have low perceived value. At the same time, urban markets, despite a high branch density, have **multitude** of low wage earners outside the financial net. Moreover, the branch timings of banks rarely coincide with the off work hours of the labour class.

Creating affordability is crucial in tapping the unbanked market. No doubt pricing is a tool, but banks also need to be innovative in right-sizing their proposition to convince customers that they can derive big value even from small amounts. One way of doing this is to show the target audience that a bank account is actually a lifestyle enabler, a convenient and safe means to send money to family or make variety of purchases. Once banks succeed in hooking customers with this value proposition they must sustain their interest by introducing simple and intuitive user application, **ubiquitous** access over mobile and other touch points, and adopting a banking mechanism which is not only secure but also reassuring to the customer. Technology is the most important element of financial inclusion strategy and an enabler of all others. The choice of technology is therefore a crucial decision, which could make or mar the agenda. Of the various selection

criteria, cost is perhaps the most important. This certainly does not mean buying the cheapest package, but rather choosing that solution which by scaling transactions to huge volumes reduces per unit operating cost. An optimal mix of these strategies would no doubt offer an innovative means of expansion in the unbanked market.

Q: 171. According to the passage, for which of the following reasons do the delivery partners fail to serve their bank's goal to expand in the unbanked markets?

1. They do not have adequate client base to sell their financial products.
2. They do not have adequate knowledge and skills to explain anything beyond basic financial products to the customers.
3. They do not have the skills to operate advanced technological aids that are a prerequisite to tap the unbanked market.

(a) Only 2

(b) Only 3

(c) All 1, 2 and 3

(d) Only

(e) Both 2 and 3

Q: 172. Which of the following facts is true as per the passage?

(a) People from rural areas have high perceived value of banking service

(b) Cost is not a valid criterion for technological package selection for financial inclusion initiatives.

(c) The inclusion segment is a singular impoverished, undifferentiated mass

(d) The branch timings of banks, generally do not coincide with the off work hours of the labour class in urban markets.

(e) All the given statements are true

Q: 173. In the passage, the author has specified which of the following characteristics of the customer onboarding process?

(a) It involves collection of documents from the applicants in order to validate their details.

(b) It involves issuance of smart cards to the customers.

(c) It suffers from latency as it takes a long time after submission of documents by the customer.

(d) It is an expensive process which people find difficult to afford

(e) All of the given characteristics have been specified

Q: 174. According to the passage, which of the following ways may help banks to

sustain the interest of their customers after hooking them?

1. Adoption of banking mechanism which is not secure but reassuring to the customers.
2. Increasing the number of delivery partners in rural market.
3. Introduction of a simple and intuitive user application

- (a) Only 1
(b) Only 3
(c) Only 2
(d) All 1, 2 and 3
(e) **Both 1 and 3**

Q: 175. According to the passage, for which of the following reasons is the viability of financial inclusion under question?

- (a) The banks always prefer the cheapest package (to cut cost) while making a choice of technology to be used
(b) The Business Correspondent Agents are highly demotivated to pursue their activity as a full time job
(c) **The investments made by banks and its delivery partners are not yielding equal amount of returns**
(d) The banks do not have adequate number of delivery partners required to tap the unbanked market
(e) The banks do not have adequate manpower to explore the diversity of the unbanked market and thereby identify the right target customers for various programs

Q: 176. What did the author try to highlight in the passage?

1. The ailing condition of financial inclusion business at present
2. Strategies that may help bank to expand in the unbanked market.
3. Role of government in modifying the existing financial inclusion policies.

- (a) **Both 1 and 2**
(b) All 1, 2 and 3
(c) Only 3
(d) Only 1
(e) Only 2

Directions: Choose the word which is most similar in meaning to the word printed in bold as used in the passage.

Q: 177. Ubiquitous

- (a) Quintessential
(b) Popular
(c) **Omnipresent**

- (d) Simplified
- (e) Abnormal

Q: 178. Multitude

- (a) Impoverished
- (b) Handful
- (c) Acknowledged
- (d) **Plenty**
- (e) Solitude

Directions: Choose the word which is most opposite in meaning to the word printed in bold as used in the passage

Q: 179. Delayed

- (a) Perturbed
- (b) Popularised
- (c) **Expedited**
- (d) Stabilised
- (e) Repressed

Q: 180. Dormant

- (a) Emaciated
- (b) Pertinent
- (c) Cornered
- (d) Rejected
- (e) **Active**

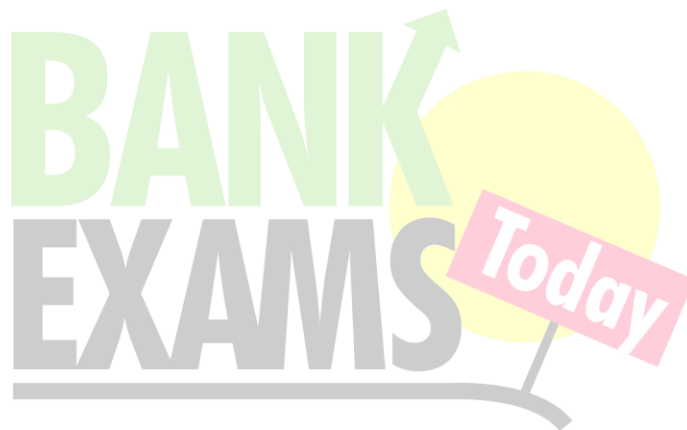

Directions: Read the following passage carefully and answer the question given below it. Certain words have been printed in bold to help you locate them while answering some of the questions.

The evolution of Bring Your Own Device (BYOD) trend has been as profound as it has been rapid. It represents the more visible sign that the boundaries between personal life and work life are blurring. The 9 am to 5 pm model of working solely from office has become archaic and increasingly people are working extended hours from a range of locations. At the very heart of this evolution is, the ability to access enterprise networks from anywhere and anytime. The concept of cloud computing serves effectively to extend the office out of office. The much **heralded** benefit of BYOD is greater productivity. However, recent research has suggested that this is the greatest myth of BYOD and the reality is that BYOD in practice poses new challenges that may **outweigh** the benefits. A worldwide survey commissioned by Fortinet chose to look at attitudes towards BYOD and security from the users point of view instead of the IT managers. Specifically the

survey was conducted in 15 territories on a group of graduate employees in their early twenties because they represent the first generation to enter the work place with an expectation of own device use. Moreover, they also represent to tomorrow's influencers and decision makers. The survey findings reveal that for financial organizations, the decision to **embrace** BYOD is extremely dangerous. Larger organizations will have mature IT strategies and policies in place. But what about, smaller financial businesses? They might not have such well-developed strategies to protect confidential data.

Crucially, within younger employee group, 55% of the people share an expectation that they should be allowed to use their own devices in the workplace or for work purposes. With this expectation comes the very real risk that employees may consider contravening company policy threats posed by this level of **subversion** cannot be overstated. The survey casts doubt on the idea of BYOD leading to greater productivity by revealing the real reason people want to use their own devices. Only 26% of people in this age group cite efficiency as the reason they want to use their own devices, while 63% admit that the main reason is so they have access to their favourite applications. But with personal applications so close to hand, the risks to the business must surely include distraction and time wasting. To support this assumption 46% of people polled acknowledged time wasting as the greatest threat to the organization, while 42% citing greater exposure to theft or loss of confidential data. Clearly, from a user perspective there is great deal of contradiction surrounding BYOD and there exists an undercurrent of selfishness where users expect to use their own devices, but mostly for personal interest. They recognize the risks to the organization but are adamant that those risks are worth taking.

Q: 181. Which of the following is not true about BYOD?

- (a) BYOD enables employees to access enterprise network from anywhere and anytime
- (b) Due to evolution of BYOD trend the 9 am to 5 pm model of working solely from office has become outdated
- (c) Recent research has confirmed that BYOD boosts organizational productivity
- (d) The concept of cloud computing facilitates the BYOD trend
- (e) All the given facts are true

Q: 182. According to the passage, the expectation of younger employees that they should be allowed to use their own devices in the work place, entails which of the following risks?

1. Younger employees may deliberately transfer confidential data of their companies to rivals if they are not allowed to use their own devices for work purpose.

2. Younger employees may strongly feel like leaving the company if it prevents usage of own device and join some other company that does not have such stringent policies.
3. Younger employees may consider flouting company policy prohibiting usage of their own devices in the workplace or for work purposes.

- (a) Only 3
(b) Only 2
(c) Both 1 and 3
(d) Only 1
(e) All 1,2 and 3

Q: 183. According to the passage, for which of the following reasons did Fortinet conduct the survey on a group of graduate employees in their early twenties?

1. As this group represents the future decision makers.
2. As this group represents the first generation who entered the workforce with a better understanding of sophisticated gadgets.
3. As this group represents the first generation to enter the workplace expecting that they can use their own devices for work purpose.

- (a) All 1, 2 and 3
(b) Only 3
(c) Both 1 and 3
(d) Only
(e) Only 2



Q: 184. According to the passage, why would the decision to embrace BYOD prove dangerous to smaller financial businesses?

- (a) Their employees have poor knowledge about their devices which in turn pose a threat to the confidential data of the organization.
(b) Their employees are more vulnerable to misplacement of devices
(c) They may lack mature IT strategies and policies required to protect confidential data
(d) They cannot afford to deal with damage liability issues of employee owned devices.
(e) Their employees have a tendency to change jobs frequently

Q: 185. What is/are the author's main objectives in writing the passage?

1. To break the myth that BYOD promotes employee efficiency and organizational productivity
2. To suggest ways to control subversion across levels of corporate chain of command.
3. To throw light upon the fact that employees even after knowing the risks involved, prefer to use their own devices for work purpose mostly for personal benefits.

- (a) Both 1 and 3

- (b) All 1, 2 and 3
- (c) Only 3
- (d) Only 1
- (e) Only 2

Q: 186. According to the findings of the survey conducted by Fortinet, why do majority of employees prefer using their own devices for work purpose?

- (a) As they often find that the devices provided by the company lack quality
- (b) As they have access to their favourite applications while working**
- (c) As majority of them believe that output doubles when they use their own devices for work purpose
- (d) As handling data from their own devices reinforces their sense of responsibility
- (e) As it helps them create a brand of their own

Directions: Choose the word which is most similar in meaning to the word printed in bold as used in the passage

Q: 187. Outweigh

- (a) Control
- (b) Venture
- (c) Perish
- (d) Determine
- (e) Surpass**

Q: 188. Heralded

- (a) Suspected**
- (b) Publicised
- (c) Dragged
- (d) Objective
- (e) Benefit

Directions: (Q. 19 and 20) Choose the word which is most opposite in meaning to the word printed in bold as used in the passage.

Q: 189. Subversion

- (a) Compliance**
- (b) Sanity
- (c) Popularity

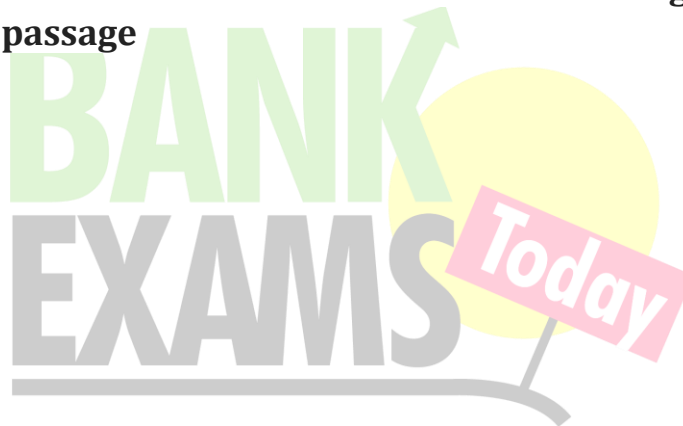

- (d) Destabilisation
- (e) Clarity

Q: 190. Embrace

- (a) Contradict
- (b) Disobey
- (c) Curtail
- (d) Reject
- (e) **Obscure**

Directions: Rearrange The Following Sections Into A Meaningful Paragraph And Answer The Questions Given Below:

- A. Unless, that is, Ethereum becomes the plaything of an imaginary kitten. Like all other cryptocurrencies that have appeared in the wake of bitcoin, and like bitcoin itself, Ethereum is useless as a medium of exchange because the price fluctuates violently and unpredictably.
- B. Last month a plague of kittens brought down one of the most fashionable cryptocurrencies on the internet.
- C. Had Ethereum been a real currency, this would have been as if the Beanie Baby craze of the last century had crashed the world's credit card system.
- D. But of course Ethereum is not a real currency, and neither is bitcoin; nor are Ripple, Monero, Litecoin, Dogecoin, or any of the other thousands of cryptocurrencies that are the focus of intense speculation today.
- E. This might not have been news, except that the cryptocurrency, Ethereum, bills itself as "the world computer" – a distributed program that can replace large parts of both the legitimate banking system and the legal system itself, since contracts can be written into computer code.
- F. But it turns out to be an excellent medium for the propagation of imaginary kittens and when a small Canadian company introduced a game that let players buy and breed cartoon cats, the resulting popularity brought the whole network briefly to its knees.

Q: 191: What is the Correct Arrangement of the sentences of the above Paragraph?

- a) DEAFBC
- b) BEACDF
- c) DEACDF
- d) **BEAFCD**
- e) BEAFDC

Solution: BEAFCD As only B is the introductory sentence so para should starts with B... Last month.....most fashionable on the internet----- this might not have been news (E)---- continuing B ethereum becomes the plaything of an imaginary kitten (A).... ethereum is useless as a medium of exchange---- but it turns out to be an excellent medium for propagation (F)----- Now sentence D should come after C as in C it is said Had ethereum been a real currency and D contradicts it by saying it is not a real currency. So the correct formation is BEAFCD.

Directions: You are provided with the sections of a sentence. You need to find out the best option which implies the same meaning and provides the grammatically and contextually correct way of combining all sections of sentences into a single one.

Q: 192: The Ministry of Corporate Affairs has taken a bold initiative/ on the occasion of Gandhi Jayanti 2016/ in Government Process Re-engineering (GPR)/ launched a Simplified Proforma/ to incorporate a Company Electronically (SPICe) e-Form

- a) On the occasion of Gandhi Jayanti 2016, launched a Simplified Proforma for Incorporating a Company Electronically (SPICe) e-Form in Government Process Re-engineering (GPR) by The Ministry of Corporate Affairs has taken a bold initiative.
- b) The Ministry of Corporate Affairs has taken a bold initiative on the occasion of Gandhi Jayanti 2016, because for incorporating Electronically (SPICe) e-Form, launched a Simplified proforma in Government Process Re-engineering (GPR).
- c) To launch a Simplified proforma to incorporate a Company Electronically (SPICe) e-Form, The Ministry of Corporate Affairs has taken a bold initiative in Government Process Re-engineering (GPR) on the occasion of Gandhi Jayanti 2016 in Government Process Reengineering (GPR).
- d) The Ministry of Corporate Affairs has taken a bold initiative in Government Process Re-engineering (GPR) and launched a Simplified Proforma for Incorporating a Company Electronically (SPICe) e-Form, on the occasion of Gandhi Jayanti 2016.
- e) None of these

Solution: d) As option I and II are contextually wrong. In III, sentence is saying that they want to launch e form so they took a bold initiative but this is not the case as it is

mentioned that eform is a bold initiative taken by the ministry which is only mentioned in option IV.

Q: 193: both MINISTRY and discipleship/ are a work for the Kingdom,/ it is important /to draw /a distinction between them.

- a) Both MINISTRY and discipleship are a work for the Kingdom so it is important to draw a distinction between them.
- b) Working for the kingdom both ministry and discipleship draw a distinction between them which is very important.
- c) Although both ministry and discipleship are a work for a Kingdom, it is important to draw a distinction between them.
- d) Because both ministry and discipleship are a work for a Kingdom, it is important to draw a distinction between them.
- e) None of these.

Solution: c) both the part of sentences are contradictory, they are not giving reasons for drawing a distinction which makes option I and IV wrong. II is also stating that both are drawing distinction because it is important which is also not the case. Only option III is correct as although joins two contradictory sentence contextually correct.

Directions: In the given sentences some words are bold which are correct except that you need to find out which part of the sentence is contextually and grammatically wrong:

Q: 194: Seven of the fatalities was in Havana, whose **decaying** historic buildings were **no match** for the force of the storm

- a) Seven of the fatalities
- b) Was in Havana, whose
- c) Historic buildings were
- d) For the force of the storm
- e) No error

Solution: b) were will be used instead of was because the subject is in plural form.

Q: 195: María Estela Pedroso, who knew the brothers, **said she** had tried to convince **the authorities** to relocate her for over a decade.

- a) María Estela Pedroso, who

- b) Knew the brothers,
- c) Had tried to convince
- d) To relocate her for over a decade.
- e) No error

Solution: c) had been trying will be used instead of had tried past perfect tense is used in the sentence which started in the past and continued for some time in the past. In the sentence, she had been trying to convince the authorities for a decade. So it continued for some time.

Q: 196: The government last year changed **the expenditure** classification to revenue and capital expenditure from the **earlier** classification of plan and non-plan expenditure.

- a) The government last year changed
- b) classification to revenue and
- c) capital expenditure from the
- d) classification of plan and non-plan expenditure.
- e) No error

Solution: e) no error

Q: 197: _____ could help with many of the region's problems, but too many _____ still stand in their way.

- (a) entrepreneurs, obstacles
- (b) people, problems
- (c) richie, disadvantage
- (d) women, advantage
- (e) men, disadvantage

Solution: a) obstacles means a thing that block's one's way. For example, obstacles stands in the way of runners. So, option (a) is correct for the second blank. Also, it satisfies the first blank as entrepreneurs have money to help.

Q: 198: Executive Board of the institution _____ its full confidence in chairman's _____ to lead. After the economic breakdown in the country.

- (a) deny, aptitude
- (b) reaffirms, ability
- (c) continues, impotence
- (d) freshen, inability
- (e) stress, strength

Solution : b) Reaffirms- confirm the validity of (something previously established)
Out of the 5 options for the first blank (b) and (c) are suitable but the second word of option (c) is not suitable in the context of the sentence (as impotence means inability). Board is reaffirming its confidence in chairman. So, option(b) is correct.

Q: 199: Beyond one's ken

- (a) out of one's reach
- (b) to think very high of oneself
- (c) a very difficult task
- (d) out of one's sight
- (e) None of these

Q: 200: Poor and dirty child who annoys people or causes minor trouble

- (a) Utopia
- (b) Unwieldy
- (c) Ubiquitous
- (d) Urchin
- (e) None of these

